



TEACHING GUIDE

4

# The SCIENCE Factor

FOR PRIMARY CLASSES

**NICOLAS BRASCH**

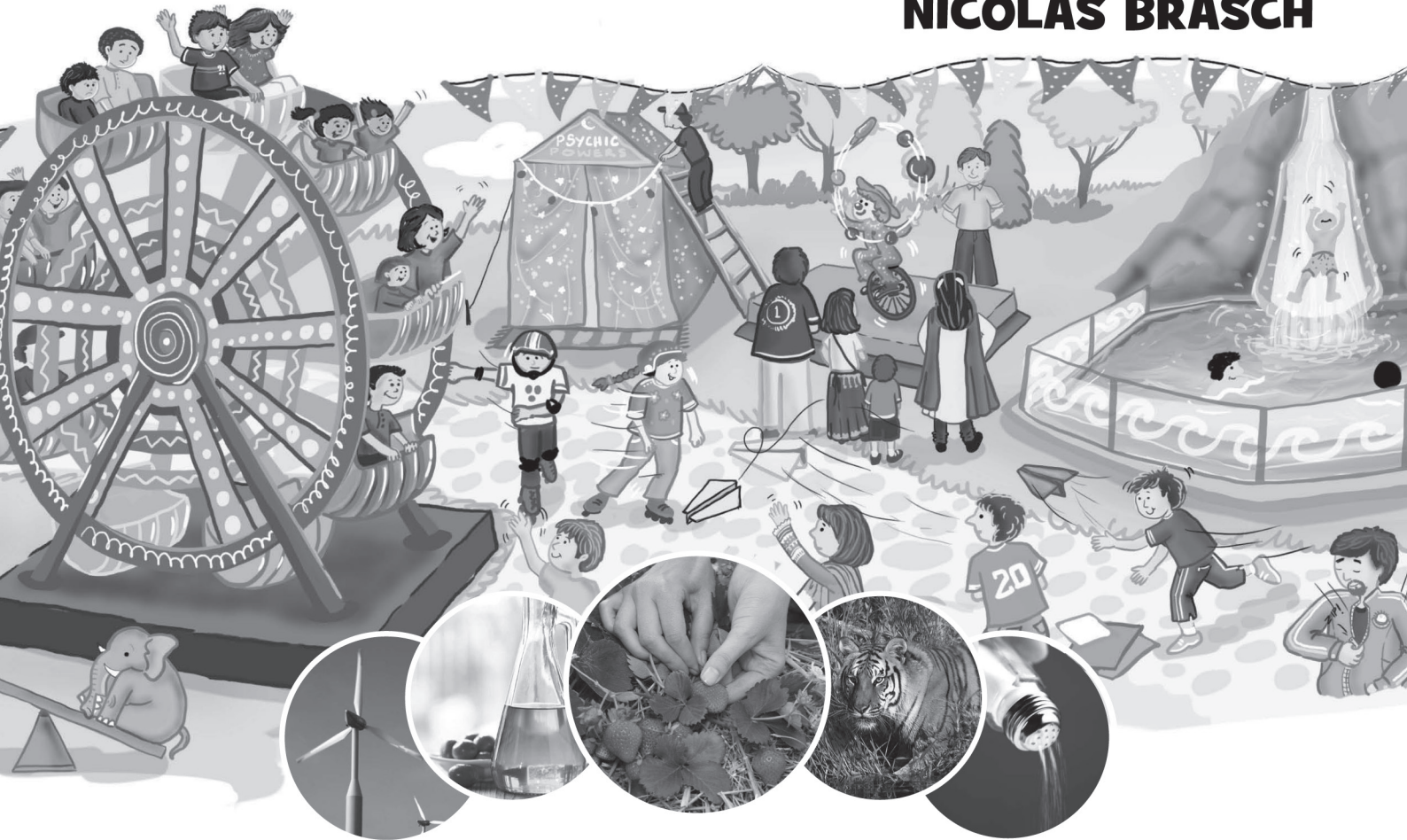

**OXFORD**  
UNIVERSITY PRESS



# CONTENTS



INTRODUCTION	iv
UNIT 1 Characteristics and life processes of organisms	2
UNIT 2 Ecosystem	13
UNIT 3 Human Health	20
UNIT 4 Matter and its Characteristics	26
UNIT 5 Forms of energy and energy transfer	31
UNIT 6 Forces and motions	38
UNIT 7 Earth and its resources	43
UNIT 8 Heat, light, and sound	48
UNIT 9 Earth in the solar system	52
UNIT 10 Technology in Everyday life	56
WORKSHEETS	58
ANSWER WORKSHEETS	78

# INTRODUCTION



## About this series

This science series has been painstakingly written, edited, and published with one aim in mind: to provide primary school students in Pakistan with a comprehensive, engaging, informative, and entertaining experience while learning about science.

The contents follow the guidelines provided by the Cambridge International Primary Programme and the UK National Curriculum for General Science.

Some students can find the idea of studying science an ordeal. They may have been exposed to learning materials that are too dry and dense: providing basic information without considering the learning needs of today's students. We have spent as much effort in making sure our series engages the student as we have on ensuring the accuracy and relevance of the content, making this an outstanding work in all respects.

## Salient features of the series

### • consistent with the nature of learning

This series stimulates students' curiosity and develops their interest in learning. It also provides them with activities that facilitate their capacity for problem solving and enable them to learn more about themselves and the world around them.

### • coherent

The ideas within this series have a logical and natural connection with each other. There is a progressive articulation of concepts, skills, and content that prepares students to understand and use more complex concepts as they advance through the learning process.

### • developmentally appropriate

In accordance with providing for all areas of a child's development (i.e. physical, social, emotional, linguistic, aesthetic, and cognitive), this series provides for:

- active exploration of the environment
- self-directed and hands-on learning activities
- balance between individual and group activities
- regular and supportive interaction with teachers and peers
- balance between active movement and quiet activities.

### • comprehensive

A great deal of work has gone into ensuring that students who work their way through this series end up with a sound knowledge of basic scientific principles that will put them in good stead for later learning, and indeed for when they have completed their formal education.

### • feasible

The combination of a student text, workbook, interactive digital resources, and teacher's guide make learning and teaching feasible and accessible, without the need to purchase other materials.

### • useful and relevant

The content in this series relates directly to students' needs and interests. It enables them to understand more about themselves and the world they live in.

## General suggestions and advice on teaching science

Students should be encouraged to share what they know, so invite discussion and foster an environment where students feel comfortable. Starting from what a student knows helps them to feel confident about learning new things.

The main focus of science at this level is to encourage the students to participate and investigate and this is done through asking and answering questions. Actively encourage the students to participate in the different experiments and share their experiences.

A good way to approach the learning and teaching of science in every lesson is outlined below—all you have to remember is S.C.I.E.N.C.E.

- S** — Start by saying what the students are going to learn about.
- C** — Constantly encourage student participation and involvement.
- I** — Investigate the topic and follow students' interests.
- E** — Encourage all students to explore and contribute by rewarding participation and praising their involvement.
- N** — Notice the interests and questions of the students and explore them further.
- C** — Consolidate what has been learnt in the lesson and link it to other topics that have been taught and the world around them.
- E** — End on a positive note and explain what has been learnt and what is coming.

### About this teacher's guide

This teacher's guide contains lesson plans, worksheets, and information that will enable teachers to actively support their students' development and provide opportunities for the students to acquire important knowledge and skills. Worksheets at the end of this guide and the workbook along with extension activities will help to reinforce and boost learning.

Teachers are encouraged to actively involve students in reinforcing concepts by interacting with the digital resources. If the required facilities are not available assign tasks from the digital resources for practice at home.

The cartoon character, Super Scientist, is the narrator and has been used for generating interest in the text. He is smart since he is a scientist, but he is prone to acting silly at times. He should be referred to and made use of for eliciting laughter wherever possible.

The Science Factor series has been enriched following the introduction of Single National Curriculum introduced by the Government of Pakistan in 2020. Consequently, The Science Factor contents follow the guidelines provided by the Cambridge International Primary Programme, the UK National Curriculum for General Science, as well as the SNC 2020 by Government of Pakistan.

The teaching guides of the series have been updated to reflect the newer content in the books and workbooks. Teachers will find lesson planning easy with our updated guides and worksheets available for the newer SLOs.

More importantly, the TGs ensure that teachers can lay the essential foundations of science concepts, to ensure that students:

- Attain the prescribed benchmarks by the end of grade 5.
- Are well prepared for the coursework required from grade 6 onwards.

To aid this endeavour, a detailed map of the new SNC provided SLOs and where they are present in the Science Factor series is provided. This invaluable planning aid will that teachers will continue to find teaching of science an enjoyable and thought-provoking process.

SNC type	grade	strand	SNC topic/chapter	SNC sub-topic	
GS	4	life science	CHARACTERISTICS AND LIFE PROCESSES OF ORGANISMS	Physical and behavioural characteristics of major groups of living things	
				Functions of major structures in living things	
			ECOSYSTEMS	Diversity of the conditions for life on Earth	
				Relationships in simple food chains	
				Competition in an ecosystem	

SNC SLOs	Location in TSF books
• Compare and contrast characteristics that distinguish major groups of living things (plant and animals)	Book 4 p 4-10
• Classify animals in terms of vertebrates and invertebrates with examples and analyze the differences and similarities in vertebrates and invertebrates.	Book 4 p 5-7
• Classify plants in terms of flowering and non-flowering with examples and analyze the differences and similarities in flowering and non-flowering plants.	Book 4 p 8-10
• Recognize and appreciate diversity in life (both plants and animals) and identify ways to protect diversity.	Book 4 p 11
• Identify major parts/organs in animals (teeth, bones, lungs, heart, stomach muscles, brain)	Book 4 p 12-22
• Relate the parts/organs of body of animals to their functions (e.g., teeth break down food, bones support the body, lungs take in air, the heart circulates blood, the stomach helps to digest food, muscles move the body).	Book 4 p 12-22
• Identify parts of a plant body (leaves, stem, flowers, seeds, roots).	Book 4 p 23
• Relate the structures of plants to their functions (i.e., roots absorb water and nutrients and anchor the plant, leaves make food, the stem transports water and food, flowers produce seeds, and seeds produce new plants).	Book 4 p 23-29
• Recognize what an ecosystem (e.g., forests, ponds, rivers, grasslands and deserts).	Book 4 p 30-39
• Explain biotic (plants, animals and humans) and abiotic (light, temperature, soil and water) and their linkages.	Book 4 p 30-45
• Analyse the way these biotic and abiotic constituents create a balance to sustain any ecosystem.	Book 4 p 44
• Recognize the interactions between animals and plants and the importance of maintaining balance within an ecosystem.	Book 4 p 44
• Describe a few food chains and analyse its structure to understand its function.	Book 4 p 42-43
• Describe the role of living things at each link in a simple food chain (e.g., plants produce their own food; some animals eat plants, while other animals eat the animals that eat plants).	Book 4 p 42-43
• Identify and describe common predators and their prey.	Book 4 p 42-43
• Recognize and explain that some living things in an ecosystem compete with each other for food and space.	Book 4 p.43
• Recognize the value of a balanced ecosystem.	Book 4 p 44
• Interpret that human actions such as urbanization, pollution and deforestation affect food chains in an ecosystem.	Book 4 p 45
• Identify various actions and roles that humans can play in preserving various ecosystems.	Book 4 p 46-47

SNC type	grade	strand	SNC topic/chapter	SNC sub-topic	
GS	4	life science	HUMAN HEALTH	Symptoms, transmission, and prevention of communicable diseases	
				Ways of maintaining good health	
physical science	MATTER AND ITS CHARACTERISTICS	States of matter and its characteristics			
		Physical properties as a basis of classifying matter			



	<b>SNC SLOs</b>	<b>Location in TSF books</b>
	<ul style="list-style-type: none"> <li>• Observe and recognize some common symptoms of illness (e.g., fever, coughing and influenza).</li> </ul>	Book 4 p 48
	<ul style="list-style-type: none"> <li>• Differentiate between contagious diseases (hepatitis, T.B, influenza and non-contagious (polio, cancer)</li> </ul>	Book 4 p 48-49
	<ul style="list-style-type: none"> <li>• Relate the transmission of common communicable diseases (e.g., touching, sneezing, and coughing) to human contact.</li> </ul>	Book 4 p 48-50
	<ul style="list-style-type: none"> <li>• Explain some methods of preventing common diseases and their transmission (e.g., vaccination, washing hands, wearing mask).</li> </ul>	Book 4 p 48-50
	<ul style="list-style-type: none"> <li>• Describe the importance of maintaining good health.</li> </ul>	Book 4 p 50
	<ul style="list-style-type: none"> <li>• Recognize everyday behaviours that promote good health (e.g., a balanced diet, drinking clean water, exercising regularly, brushing teeth, getting enough sleep)</li> </ul>	Book 4 p 50
	<ul style="list-style-type: none"> <li>• Define balanced diet and explain its components.</li> </ul>	Book 4 p 51-56
	<ul style="list-style-type: none"> <li>• Identify common food sources included in a balanced diet (e.g., fruits, vegetables, grains, milk and meat group).</li> </ul>	Book 4 p 51-56
	<ul style="list-style-type: none"> <li>• Understand the value of clean drinking water and inquire about the factors that generally make it unclear.</li> </ul>	Book 4 p 57
	<ul style="list-style-type: none"> <li>• Explore a few ways that can help make water clean and suitable for drinking (water filtration and boiling).</li> </ul>	Book 4 p 57
	<ul style="list-style-type: none"> <li>• Describe matter and its states.</li> </ul>	Book 4 p 58
	<ul style="list-style-type: none"> <li>• Describe characteristics of each state of matter with examples.</li> </ul>	Book 4 p 59-62
	<ul style="list-style-type: none"> <li>• Compare and sort objects and materials on the basis of physical properties (e.g., mass, volume, states of matter, ability to conduct heat or electricity, ability to float or sink in water).</li> </ul>	Book 4 p 63-64
	<ul style="list-style-type: none"> <li>• Explore the properties of metals (i.e. appearance, texture, colour, odour, density).</li> </ul>	Book 4 p 65-66
	<ul style="list-style-type: none"> <li>• Identify properties of metal (conducting heat and electricity) and relate these properties to use of metals (i.e. a copper electrical wire, an iron cooking pot).</li> </ul>	Book 4 p 65-66

SNC type	grade	strand	SNC topic/chapter	SNC sub-topic			
GS	4	physical science	FORMS OF ENERGY AND ENERGY TRANSFER	Common sources and uses of energy			
				Light and sound in everyday life			
				Heat transfer			
				Electricity and simple electric circuits			
		earth and space science	THE EARTH AND ITS RESOURCES	Familiar forces and the motion of objects			
				Simple machines			
				Physical characteristics of Earth - Earth's resources			

	<b>SNC SLOs</b>	<b>Location in TSF books</b>
	• Identify sources of energy (e.g., the Sun, flowing water, wind, coal, oil, gas).	Book 4 p 67
	• Recognize that energy is needed to do work, (e.g. for moving objects), heating and lighting.	Book 4 p 67
	• Describe and demonstrate the transformation of energy.	Book 4 p 68
	• Understand the importance of energy conservation.	Book 4 p 68, 97-98
	• Recognize the role and responsibility of humans to conserve energy resources.	Book 4 p 68, 97-98
	• Relate familiar physical phenomena (i.e., shadows, reflections, and rainbows) to the behaviour of light.	Book 4 p 68-70
	• Relate familiar physical phenomena (i.e., vibrating objects, echoes) to the production and behaviour of sound.	Book 4 p 71-73
	• Recognize that warmer objects have a higher temperature than cooler objects.	Book 4 p p 74
	• Investigate the changes that occur when a hot object is brought in contact with a cold object.	Book 4 p 74
	• Identify ways to measure temperature and understand its unit.	Book 4 p 74-75
	• Describe and demonstrate that electrical energy in a circuit can be transformed into other forms of energy (e.g., heat, light, sound).	Book 4 p 76-79
	• Explain and provide reasoning that a simple electric circuit requires a complete electrical pathway.	Book 4 p 76-79
	• Describe force and motion with examples from daily life	Book 4 p 80
	• Identify gravity as a force that draws objects to Earth.	Book 4 p 80-81
	• Investigate that frictional force works against the direction of motion.	Book 4 p 82
	• Provide reasoning with evidence that friction can be either detrimental or useful under different circumstances.	Book 4 p 84
	• Recognize that simple machines, (e.g., levers, pulleys, gears, ramps) help make motion easier (e.g., make lifting things easier, reduce the amount of force required, change the distance, or change the direction of the force).	Book 4 p 84-89
	• Recognize that earth's surface is made up of land and water and is surrounded by air.	Book 4 p 90
	• Recognize that water in rivers and streams flows from mountains to oceans or lakes.	Book 4 p 90-92
	• Identify some of Earth's natural resources that are used in everyday life (e.g., water, wind, soil, forests, oil, natural gas, minerals).	Book 4 p 93-94
	• Recognize that some remains (fossils) of animals and plants that lived on Earth a long time ago are found in rocks, soil and under the sea.	Book 4 p 93
	• Differentiate between renewable and non-renewable resources	Book 4 p 95
	• Investigate the impact of human activities on Earth's natural resources	Book 4 p 96
	• Suggest the ways to conserve the natural resources.	Book 4 p 97-98

SNC type	grade	strand	SNC topic/chapter	SNC sub-topic	
GS	4	earth and space science	EARTH'S WEATHER AND CLIMATES		
			EARTH IN THE SOLAR SYSTEM	Objects in the Solar System and their Movements	
				Earth's motion and related patterns observed on Earth	
		STEM	TECHNOLOGY IN EVERYDAY LIFE	Solar and Lunar eclipses	
				Basic Craft Making	
				Technical activities	
				Elementary first aid	

	<b>SNC SLOs</b>	<b>Location in TSF books</b>
	• Understand the difference between weather and climate.	Book 4 p 99-100
	• Relate weather (i.e., daily variations in temperature, humidity, precipitation in the form of rain or snow, clouds, and wind) changes with changing geographical location.	Book 4 p 100
	• Recognize that average temperature and precipitation can change seasons and location.	Book 4 p 100-101
	• Describe and demonstrate the Solar System with planets revolving around the sun.	Book 4 p 102-105
	• Identify the sun as a source of heat and light for the Solar System	Book 4 p 102
	• Recognize that the earth has a moon that revolves around it, and from earth the moon looks different at different times of the month.	Book 4 p 106
	• Investigate and explain how day and night are related to Earth's daily rotation about its axis, and provide evidence of this rotation from the changing appearance of shadows during the day.	Book 4 p 107
	• Describe how seasons in Earth's Northern and Southern hemispheres are related to Earth's annual movement around the Sun.	Book 4 p 108
	• Illustrate and explain how solar and lunar eclipses occur.	Book 4 p 109
	• Practice techniques of folding, cutting, tearing and pasting papers. Cardboards to make objects and patterns	Book 4 p 110
	• Design paper bags, envelopes, cards and face masks	Book 4 p 111-112, 114
	• Design models of sphere, cube, prism, cylinder and cone with clay or playdough	Book 4 p 113
	• Design hammer, wheels, rollers and gears using clay or play dough	Book 4 p 113
	• Operate mobile phones for use of calculator, alarm clock and calendar	Book 4 p 116
	• Operate mobile phones for taking snap shots	Book 4 p 116
	• Recognize the items of first aid box.	Book 4 p 114
	• Use digital and clinical thermometer externally to measure body temperature.	Book 4 p 115
	• Check blood pressure by digital blood pressure monitor	Book 4 p 115



# UNIT 1 CHARACTERISTICS AND LIFE PROCESSES OF ORGANISMS

## Background

This unit builds on the characteristics distinguishing major groups of living things/organisms as well as their further classifications. It elaborates on differences and similarities between different groups of organisms and recognizes diversity. The unit also identifies the major parts/organs in animals and relates them to their functions. Use the activities in this guide as well as the Student's Book and Workbook to make your lesson enjoyable. They will also help to strengthen and reinforce these concepts.

## Learning outcomes

Students should be able to:

- compare and contrast characteristics that distinguish major groups of living things (animals and plants).
- classify animals in terms of vertebrates and invertebrates with examples and analyse the differences and similarities between vertebrates and invertebrates.
- classify plants in terms of flowering and non-flowering with examples and analyse the differences and similarities in flowering and non-flowering plants.
- recognize and appreciate diversity in life (both plants and animals) and identify ways to protect diversity.
- identify the major parts/organs in animals (teeth, bones, lungs, heart, stomach muscles, brain).
- relate the parts to their functions (e.g., teeth break down food, bones support the body, lungs take in air, the heart circulates blood, muscles move the body, stomach helps to digest food).
- identify the different parts of a plant (leaves, stem, flowers, seeds, roots).
- relate the major parts to their functions (roots absorbs water and nutrients and anchor the plant, leaves make food, the stem transport water and food, flowers produce seeds, and seeds produce new plants).

## Resources

- Student's Book pages 4-29
- Workbook pages 2-12
- A few plants (flowering and non-flowering)
- A printout of a skeleton (not labelled) on an A3 paper or bigger
- Worksheets with a plant (for labelling and colouring)

## Student's Book steps

1.
  - Welcome the students into the class and ask them to sit at their tables.
  - Explain that they are going to be learning about different living things, i.e., animals and plants and their classifications, but first, use word association games to check how much do they already know.
  - Read the passages about the classification of living things and their characteristics and have a discussion.
  - Ask the students to pair up in teams of two and name a few living things around them. Ask them to make a list.
  - Tell them to select at least two living things (or more) from this list and observe their characteristics and behaviors.
  - Ask them to prepare a presentation and present their findings with the class the next day using any pictures or information they like.
2.
  - Welcome the students into the class and ask them to sit at their tables.
  - Review what they had discussed in the previous class and encourage students to ask questions.
  - Arrange pots of flowering and non-flowering plants e.g. Rose, ferns, etc.
  - Encourage the students to gather around the different pots and identify their features as well as what category they belong to.
  - Ask them to differentiate between the different plants and ask if they have seen any of these plants in their surroundings.
  - This may also be a good time to discuss the importance of planting trees and other plants.
3.
  - Welcome the students into the class and ask them to sit at their tables.
  - Explain that they are going to be learning about animal anatomy, but first you will see what they already know.
  - Ask them to feel with their tongue the different teeth they have and ask them to describe how they differ, e.g., some are pointed, some are smaller than others etc.
  - Explain to them the different types of teeth and have a discussion on oral hygiene as well as its consequences.
  - Ask the students to guess how many bones they have in their body and to name as many as they can by showing a raise of hands.
  - Have an unlabeled skeleton print stuck on the board and label each with the class while encouraging them to simultaneously feel those specific bones in their bodies.

- 4.**
- Welcome the students into the class and ask them to sit at their tables.
  - Write keywords of the sub-topics on the board; teeth, bones, muscles, lungs, heart, stomach and brain.
  - Instruct students to point towards the body part they read out e.g. teeth, heart etc.
  - Divide the students into 7 or 14 groups (depending on the class size), assign them one keyword and ask them to list down all the functions that body part may have and why is it important.
  - Give them some time to work on this and then call each group to the front of the class to present.
- 5.**
- Welcome the students into the class and ask them to sit at their tables.
  - Discuss the parts of plants and their functions
  - Give students a worksheet with a plant on it and ask them to label and color it
  - Discuss processes such as Photosynthesis, Transportation etc. and their importance. You may use videos to help understanding and engagement.
- 6.**
- Welcome the students into the class and ask them to sit at their tables.
  - Revise the contents of the last class, specifically plant processes
  - Ask the students to go outside and get a green leaf
  - Ask them to keep the leaf on their desk or somewhere safe and observe as the color fades over time until the leaf is dried
  - Explain to them why this happens (transportation)

### **Activities**

- Arrange the students in groups or individually and read aloud the activities. Follow the instructions given in the Student's Book and Workbook.
- Help the students answer the questions from "In your notebook" and "Learning is fun" etc. Remind them that all the answers are in the Student's Book.

### **Workbook steps**

Help the students solve answers and activities in the Workbook. They may do these individually in class or as homework or they may work in groups of 2-3. After completing each task from the workbook, students may compare their answers and check their answers with each other.



## STUDENT'S BOOK ANSWERS

### In your Notebook (pg 7)

1. Warm-blooded animals: Humans, horses, cats etc.  
Cold-blooded animals: fishes, sharks etc.  
Animals living on land: Humans, cats, dogs, etc.  
Animals living in water: Fishes, sharks, sea horses etc.  
Animals that live on land and water: turtles, sea lions etc.  
Animals that have feathers: birds  
Animals that have fur or hair: cats  
Animals that have scales: fishes
2. Scientists classify animals by looking at many physical features e.g. whether they are warm or cold blooded, how they give birth to their young, whether they live on land or in water, and whether they have feathers, fur/hair or scales.

### Learning is Fun (pg 12)

1. Classification is done to make it easier to talk about and study things as things that share common features are grouped together.
2. Some similarities are:
  - Both need food and water
  - Both need air to breathe
  - Both reproduce
3. Some differences are:
  - Vertebrates have a backbone; invertebrates do not have a backbone or spinal column
  - Vertebrates are less than 5% of all animals on Earth; invertebrates are more than 95% of all animals on Earth
  - Vertebrates do not have an external skeleton; invertebrates have an external skeleton
  - Vertebrates are comparatively larger in size than invertebrates
4. Some differences are:
  - Gymnosperms do not produce seeds and fruits; angiosperms produce seeds and fruits for reproduction
  - Gymnosperms reproduce using spores or other vegetative means; angiosperms reproduce using seeds and fruits

5. They are similar because:

- All produce their own food
- All have same parts, but with different complexity levels

They are different because, some are flowing and some are non-flowing and flowing plants produce seeds and fruits for reproduction, while non-flowing plants do not produce seeds and fruits and reproduce using spores or other vegetative means.

6. Biodiversity is important because each type of plant and animal has specific features and plays an important role in our lives. These different plants and animals help each other survive and function together, if one is disturbed, the entire system of nature may be disturbed and cause many problems. We can protect biodiversity by treating the natural environment with care and responsibility e.g. not waste water, not spread garbage or cut trees etc.

### **In your Notebook (pg 16)**

1. A human adult body has 206 bones. A human child body has more than 300 bones.
2. When a child grows up, some of his bones knit together to form larger bones.

### **In your Notebook (pg 17)**

1. You have bones to support your body and stop it from collapsing to the ground, to protect your internal organs from damage, to keep your internal organs in place and to work with your muscles and tendons to enable you to move.
2. It is important to have strong bones so that they can carry out the above functions and not be damaged.

### **In your Notebook (pg 18)**

1. Muscles help you move and also help you move things around your body.
2. Muscles work by contracting and relaxing to help you move.

### **In your Notebook (pg 21)**

1. When you breathe in, your lungs get bigger as they take oxygen from the air. This oxygen is then transferred into your body and pumped around your body.
2. When you breathe out, you are getting rid of carbon dioxide that your body doesn't need.

### **In your Notebook (pg 23)**

The intestines take food from your stomach and transport waste food to your anus, where it leaves your body. As the food travels along the intestines, it is broken down so that it is broken down so that it is absorbed in the blood and used up by the body.

### In your Notebook (pg 24)

Leaves are the place where food is produced. The system of producing food is called photosynthesis. Leaves contain a green substance called chlorophyll (which is why leaves are green most of the time). The chlorophyll converts energy from the Sun and when this is combined with water and carbon dioxide, food is produced.

### In your Notebook (pg 27)

1. For photosynthesis to occur, plants need four things:

- Water
- carbon dioxide
- sunlight
- chlorophyll

2. A plant collects water from the ground, it gets sunlight from the Sun and it breathes in carbon dioxide (a gas) from the air. Photosynthesis takes place in the leaves. Leaves contain a substance called chlorophyll. The chlorophyll changes the sunlight so it can be used by the plant. When the carbon dioxide and water react in the presence of sunlight, a type of sugar called glucose and oxygen, are created. The glucose is the food that helps the plant to grow. The oxygen leaves the plant and goes into the air.

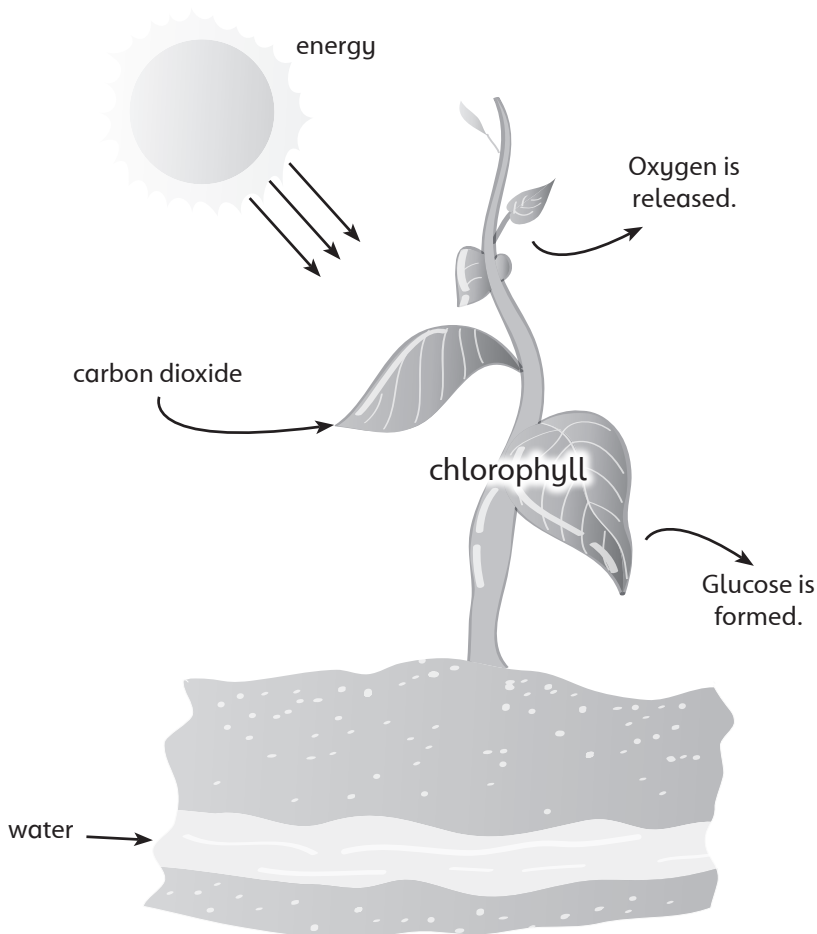

3. Discussion based/subjective answer. Justify your answer/reasons for answering yes or no.

### Learning is Fun (pg 29)

1. The functions of the following parts are:

- Roots: absorb water and minerals from the ground. They also help to anchor the plant in the ground
- Stem: transports water up the plant. It also supports the leaves and flowers, particularly against wind. Some stems have spikes or hairs that protect the plant from insects and small animals. The cactus uses its stem to store water
- Leaf: the place where food is produced. The system of producing food is called photosynthesis. Leaves contain a green substance called chlorophyll (which is why leaves are green most of the time). The chlorophyll converts energy from the Sun and when this is combined with water and carbon dioxide, food is produced
- Flower: produce seeds which form new plants. However, not all plants have flowers.

2. There are four main processes that enable plants to live, grow, and reproduce. These processes are photosynthesis, transpiration, transportation, and reproduction.

(write a short note on each from pages 24-29)

3. Plant fertilization occurs when pollen grains transfer from the anther of one plant to the stigma of another plant. From the stigma, the pollen goes down the tube to the ovary, where a seed is formed.

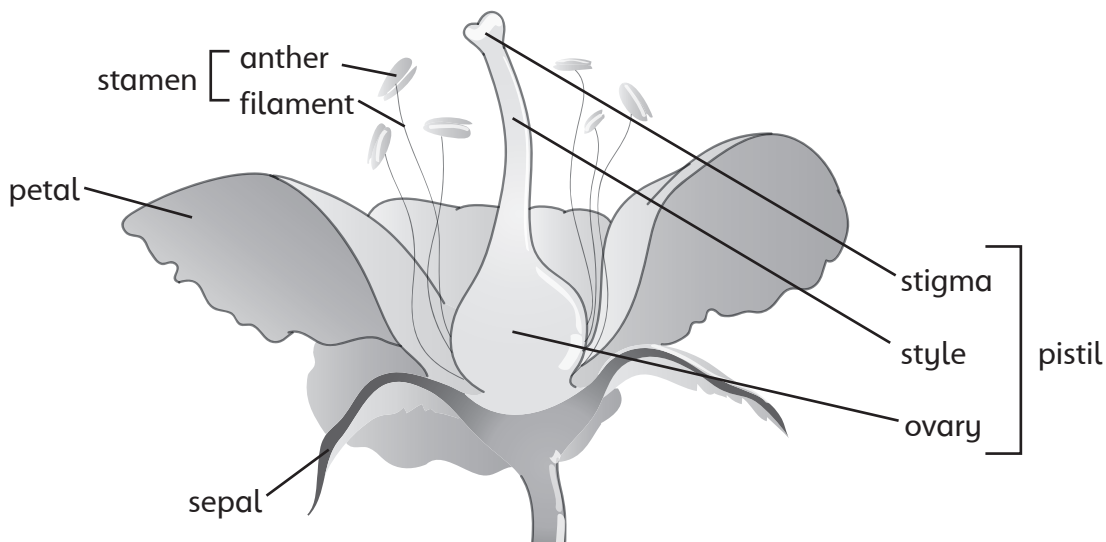

## WORKBOOK ANSWERS

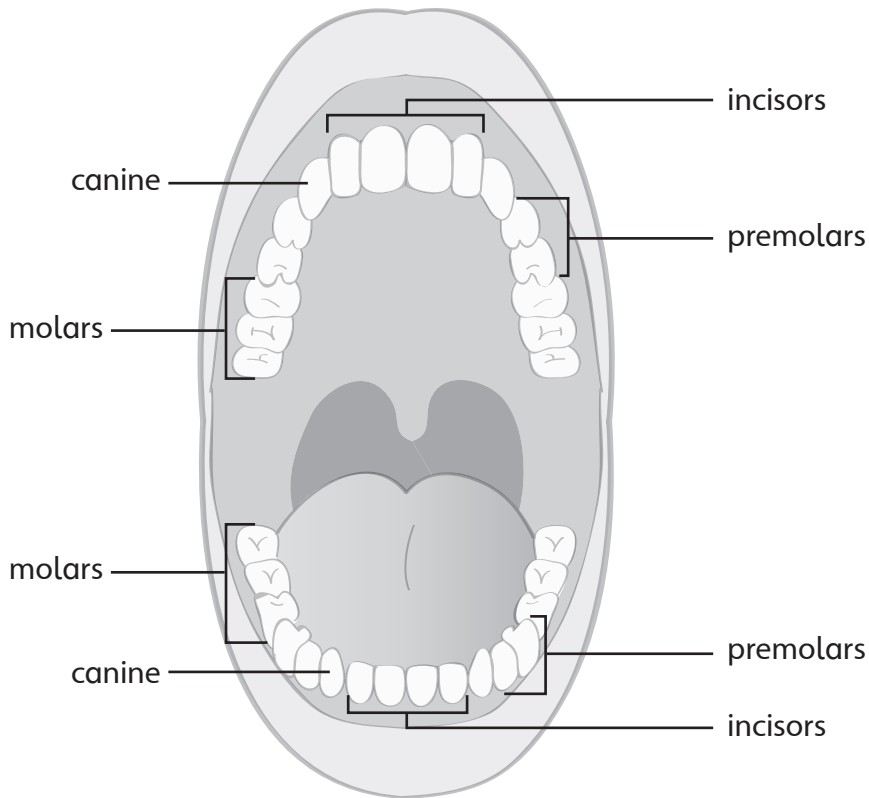

### Body organs quiz

1. A
2. B
3. C
4. B
5. A
6. B
7. C
8. C
9. B

### Parts of the body anagrams

1. Brain
2. Heart
3. Intestines
4. Skin
5. Tongue
6. Ventricle

## A message for you

I need water and food to live. I also need energy to help me to grow.

## Move the animals

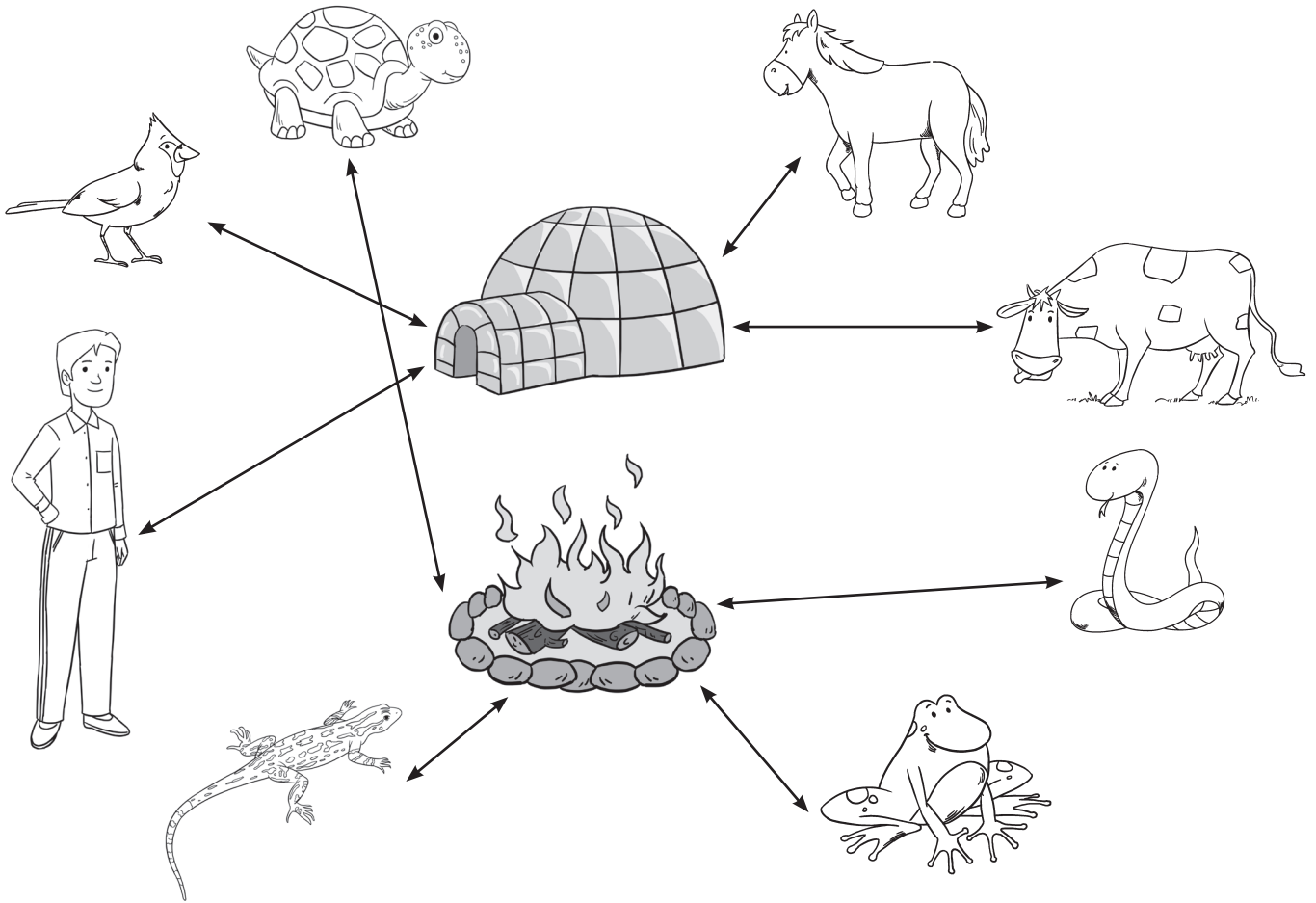

## More or animals

I.

1. B
2. B
3. D
4. B

**II. Identify the locations of the following parts.**

- Brain
- Heart
- Lungs
- Skeleton
- Teeth

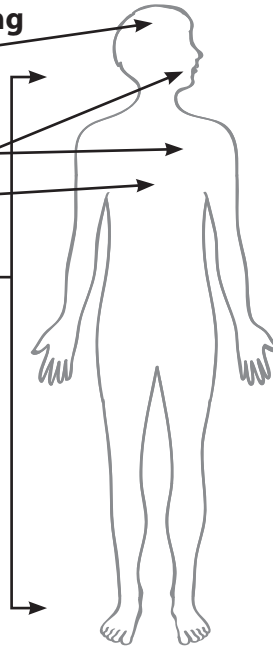

**Purpose of plants**

Flowers produce seeds which form new plants. However, not all plants have flowers.

The roots absorb water and minerals from the ground. They also help to anchor the plant in the ground.

The stem has several functions. It transports water up the plant. It also supports the leaves and flowers, particularly against wind. Some stems have spikes or hairs that protect the plant from insects and small animals. The cactus uses its stem to store water.

Leaves have a very important function. They are the place where food is produced. The system of producing food is called photosynthesis. Leaves contain a green substance called chlorophyll (which is why leaves are green most of the time). The chlorophyll converts energy from the Sun and when this is combined with water and carbon dioxide, food is produced.

**Plant quiz**

I.

1. F
2. F
3. T
4. T
5. T
6. F
7. F
8. F
9. F
- 10.F

II. Sun, ground/roots, leaves, air. Chlorophyll, water and carbon dioxide, sunlight.

### III. Wordsearch

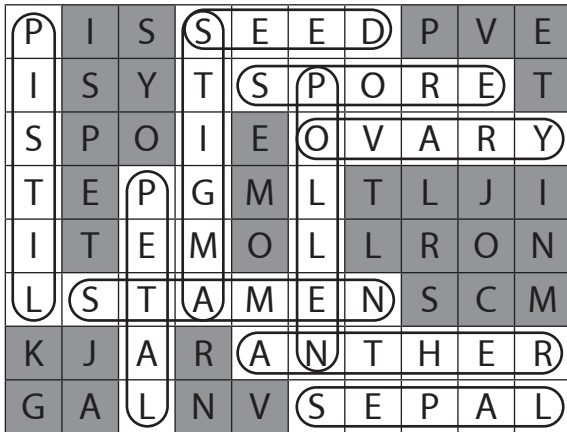

pistil	seed
spore	ovary
anther	stamen
pollen	petal
stigma	sepal

### Leaf crossword

across

1. Chlorophyll

Down

1. Carbon
2. Sunlight
3. Sugar
4. Plants
5. Oxygen

### How plants grow

1. Sun
2. Glucose (food) and oxygen
3. Leaves
4. Roots

### Plant puzzle

Across

- |                |                   |              |         |
|----------------|-------------------|--------------|---------|
| 3. Chlorophyll | 5. Transportation | 8. Processes | 9. Root |
|----------------|-------------------|--------------|---------|

Down

- |                  |           |           |          |
|------------------|-----------|-----------|----------|
| 1. Transpiration | 2. Xylem  | 4. Leaves | 6. Rings |
| 7. Stomata       | 8. Phloem |           |          |





# UNIT 2 ECOSYSTEMS

## Background

This unit builds on the different types of ecosystems and the functions and interactions between each member as well as what contributes to differences in ecosystems. The unit identifies and appreciates diversity and the essential role it plays along with exploring some of the ways modern processes impact various ecosystems. Use the activities in this guide as well as the Student's Book and Workbook to make your lesson enjoyable. They will also help to strengthen and reinforce these concepts.

## Learning outcomes

Students should be able to:

- recognize what is an ecosystem (e.g., forests, ponds, rivers, grassland, deserts).
- explain biotic (plants, animals, and humans) and abiotic (light, temperature, soil, and water) and their linkages.
- recognize and appreciate diversity in life (both plants and animals) and identify ways to protect it.
- describe food chains and analyse its structure to understand its function.
- describe the roles of living things at each link in a simple food chain (e.g., plants produce their own food, some animals eat plants, while other animals eat the animals that eat plants).
- identify and describe common predators and their prey.
- analyse the way the biotic and abiotic constituents create a balance to sustain any ecosystem.
- recognize and explain that some living things in an ecosystem compete with each other for food and space.
- recognize the interactions between animals and plants and the importance of maintaining balance within an ecosystem.
- recognize the value of a balanced ecosystem.
- interpret that human actions such as urbanization, pollution and deforestation affect food chains in an ecosystem.
- identify various actions and roles that human can play in preserving various ecosystems.

## Resources

- Student's Book pages 30-47
- Workbook pages 13-19
- 6-7 pictures printed on A4 papers

## Student's Book and lesson ideas

1.
  - Welcome the students into the class and ask them to sit at their tables.
  - Explain that they are going to be learning about different ecosystems and play a short 3–5-minute video (chosen by the teacher) containing various ecosystems such as terrestrial regions including deserts, forests, grasslands, polar and aquatic regions. The video must include animals and plants along with land and water resources available on Earth; to introduce the topic.
  - Read the passages pertaining ecosystems i.e., what makes up an ecosystem, the different types of ecosystems, etc. and have a discussion.
  - While discussing each ecosystem, ask the students to imagine themselves as part of that ecosystem and describe what they feel there
2.
  - Welcome the students into the class and ask them to sit at their tables.
  - Print six to seven pictures on A4 sized papers of various activities being carried out in different ecosystems e.g., a lion hunting a deer in the desert, a beaver making a dam with logs of wood, a bird feeding her chicks in a nest, a polar bear sleeping on ice, etc.
  - Show the pictures to the students one-by-one and ask them to give their opinions and statements on what they understand from the picture.
3.
  - Welcome the students into the class and ask them to sit at their tables.
  - Recap what you had discussed in previous classes and introduce to them the concept of food chains and webs
  - Ask them to identify and draw a food chain and a food web around them
  - Discuss in class the different food chains and food webs students draw and give examples from other ecosystems as well.
4.
  - Welcome the students into the class and ask them to sit at their tables.
  - Ask them to recall how many packets of junk food or plastic bottles they saw on their way to school.
  - Explain to them the harmful practices done by humans e.g. pollution and why it is important to keep the earth, water and air clean.
  - You may organize a beach or park clean-up at this point with the consent of the school and parents.

## Activities

- Arrange the students in groups or individually and read aloud the activities. Follow the instructions given in the Student's Book and Workbook.
- Help the students answer the questions from "In your notebook" and "Learning is fun" etc. Remind them that all the answers are in the Student's Book.

## Workbook steps

Help the students solve answers and activities in the Workbook. They may do these individually in class or as homework or they may work in groups of 2-3. After completing each task from the workbook, students may compare their answers and check their answers with each other.

## STUDENT'S BOOK ANSWERS

### In your Notebook (pg 32)

1. An ecosystem is made of all things, living and non-living in an area, and their relationship to each other. It is an area within an environment in which an animal lives and is active.
2. Biodiversity refers to the differences in an ecosystem, i.e., the types of animals and plants it can have living within it.

### In your Notebook (pg 39)

1. Grasslands are defined as areas where grasses predominate over large bushes or trees. Some grasslands may have woody plants, shrubs, or trees. Temperatures in temperate grasslands vary significantly from summer to winter, and rainfall is lower than in savannas. Grassland supports a diverse range of animals, reptiles, birds, and insects. Animals like giraffes, ostriches, jaguar, white rhinos, elephants, and foxes are commonly found in grasslands. In Pakistan, grassland ecosystems are found in Gilgit, Kashmir, Waziristan and Chitral.
2. List all features and identify similarities and differences (either as a table, example given below or as paragraphs)

	Deserts	Grasslands	Polar regions	Rainforests	Seas, rivers and oceans
Weather	Hot during the day, cold during the night. Dry (little/no rain)	Temperature varies from summer to winter. Lower rainfall than savannas.	Very cold. Dry.	Very wet.	

Landscape	Lots of rocks and mountains	Large bushes or trees	Surrounds the two poles (North and South Pole) and is covered with ice.	Lots of trees and other plants	Under water
Animals and plants	Camel and cacti	Giraffes, ostriches, elephants, woody plants, shrubs, trees	Penguins, Polar bears, grasses, small woody shrubs, ferns	Lots of different types of animals and plants live here e.g. gorillas, monkeys, snakes. Trees, shrubs,	Whales, sea horses, alligators, corals, sea weed, mangroves

3. a. Deserts: animals that can survive a long time in heat and without much water
- b. Polar regions: animals that have lots of fur, thick feathers or a layer of fat
- c. Seas and rivers: animals that can breathe underwater and swim (have gills and fins etc.)

### **In your Notebook (pg 44)**

1. Energy is important because it helps living things to carry out day to day activities e.g., to breathe, grow, move, repair damage to the body and so on.
2. Animals obtain this energy through food i.e.; energy is transferred from one animal to another animal via consumption. The food chain helps us understand this.

### **In your Notebook (pg 45)**

1. Humans often go into other ecosystems to find food, take resources to make things or just for fun.
2. Careless human activity during visits can destroy entire ecosystems. Pollution, deforestation and the spread of towns and cities can reduce the abiotic elements that some of the animals and plants rely on for survival.

### **In your Notebook (pg 47)**

- a. Because if the Earth becomes polluted, trees and plants will not be able to grow. Humans need trees and plants to produce the oxygen that we breathe. Humans also need plants for food, and trees for shelter.
- b. Because we need to drink clean water. We also need to keep bodies of water clean so that fish can live and grow.
- c. Because we need to breathe clean air. If the air is not clean, humans may become ill— and even die. Other animals also depend on fresh air.

## Learning is Fun! (pg 47)

1. Describe your ideal ecosystem. Mention what the weather and landscape would be like, what plants and animals would live there and so on.
2. Because each animal or plant has specific features and plays an important role in our ecosystems. Disturbing any one living organism can disturb the entire nature and cause problems. Different types of plants and animals help each other survive on Earth. It is also important because it means animals and plants do not have to compete for the same food, water, and shelter.
3. Because different ecosystems provide resources for living things to survive. They provide us with shelter, food, water, raw materials and so on and if they are not conserved, there will be a loss of habitat as well as increased competition which will affect the balance of nature and make it extremely difficult for us to survive.
4. The living things in ecosystems are known as biotic, and the non-living things as abiotic. They work together to keep the ecosystem working and balanced. A balanced ecosystem is that in which there no shortages in availability of biotic or abiotic elements in an area, so that living things may survive and resources are not scarce, otherwise they may either die off or move to other areas e.g. to hunt or live.
5. Give reasons for why or why not and explain using examples to support your claim.

## WORKBOOK ANSWERS

### Biotic or Abiotic?

I.

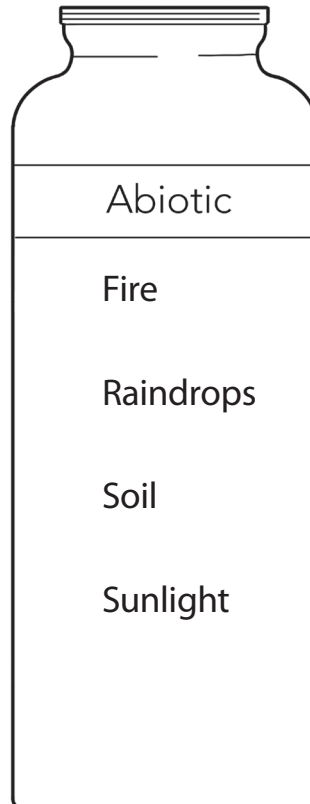
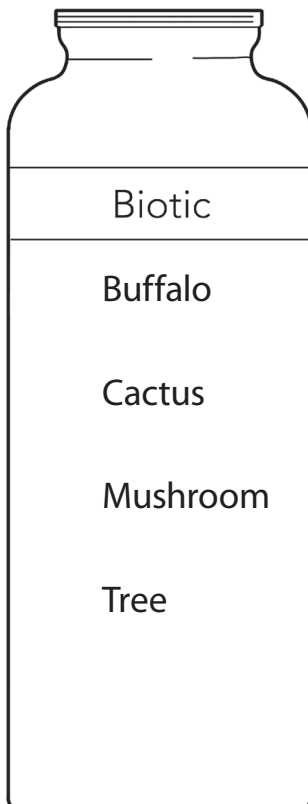

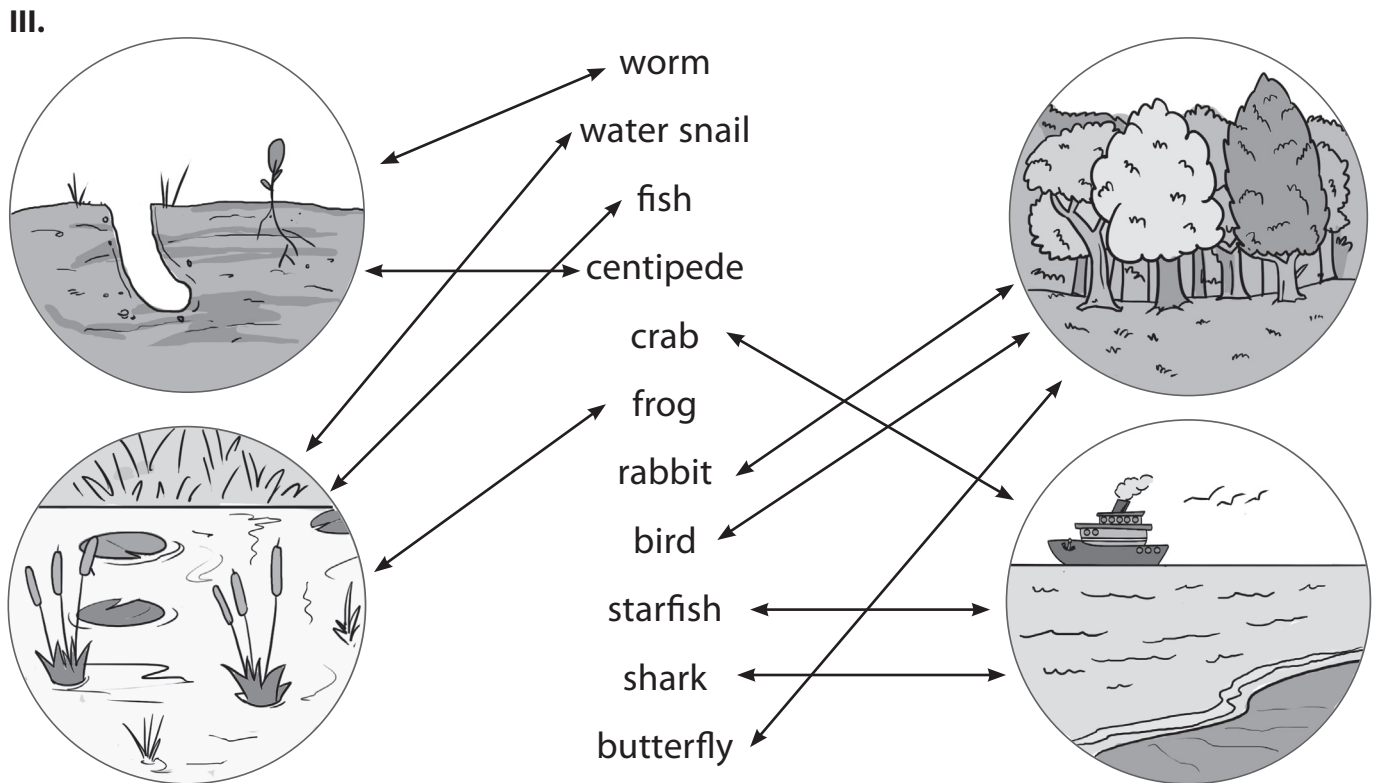
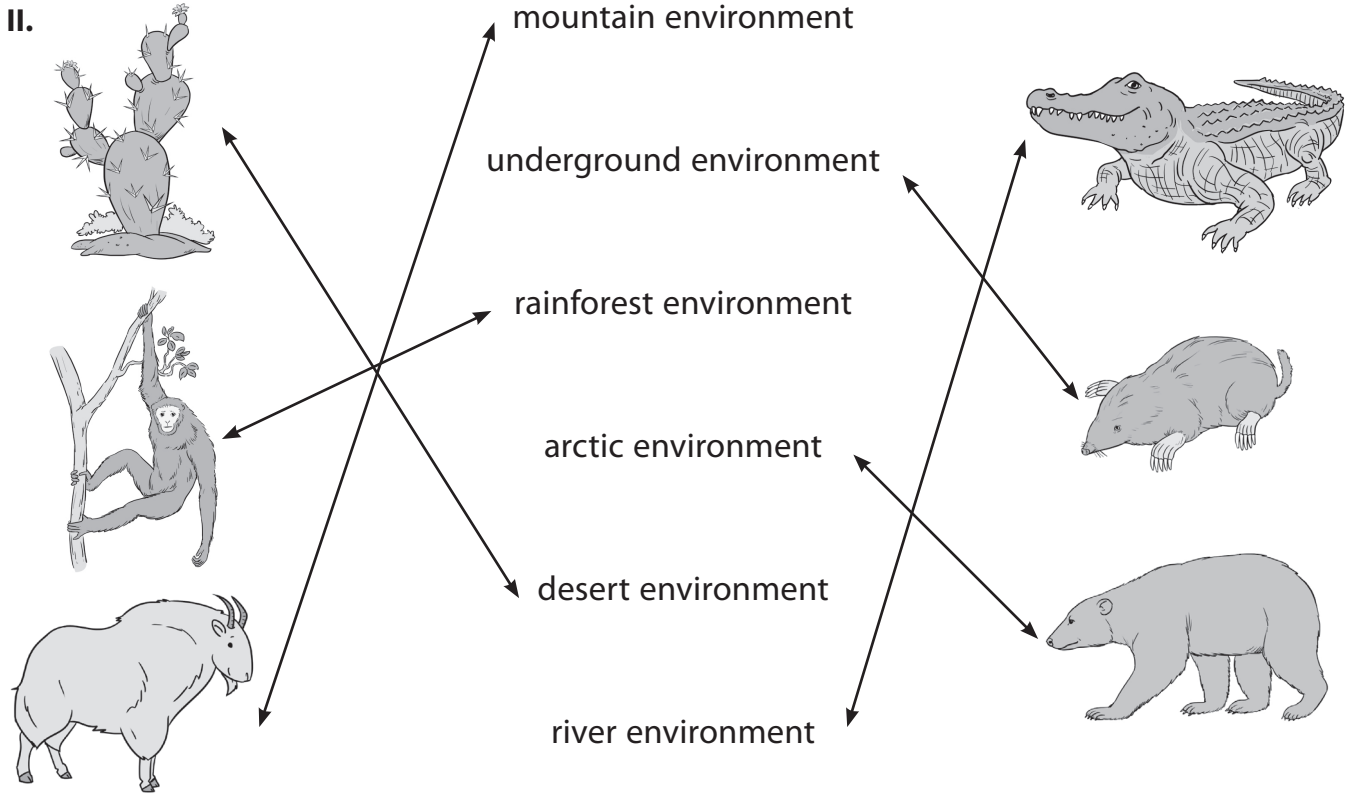

## Ecosystems of the world

Emergent zone

Canopy zone

Understorey

Forest floor

## From producer to consumer

Producer → primary consumer → secondary consumer → tertiary consumer

## Missing vowels

1. Antarctica
2. Sahara Desert
3. Rainforest
4. Africa, Asia, Australia, South America
5. Carbon dioxide
6. Temperature
7. Ice
8. Adapt
9. Food, water, shelter

## Odd one out

1. Elephant
2. Macaw
3. Lion
4. Frog
5. Gecko
6. Koala bear
7. Tortoise
8. Snow leopard
9. Ostrich
10. Lynx

## Conservation quiz

1. C                      2. C                      3. D                      4. C                      5. D



# UNIT 3 HUMAN HEALTH

## Background

This unit builds on the student's knowledge of diseases and illness as well as its prevention. The unit focuses on the importance of good health and the factors contributing to it. Use the activities in this guide as well as the Student's Book and Workbook to make your lesson enjoyable. They will also help to strengthen and reinforce these concepts.

## Learning outcomes

Students should be able to:

- observe and recognize some common symptoms of illness (e.g., fever, coughing, influenza).
- differentiate between contagious diseases (hepatitis, T.B, influenza, and polio) and noncontagious (cancer and diabetes).
- relate the transmission of common communicable diseases (e.g., touching, sneezing, coughing) to human contact.
- explain some methods of preventing common diseases and their transmission (e.g., vaccination, washing hands, wearing mask).
- describe the importance of maintaining good health.
- recognize everyday behaviours that promote good health (e.g., a balance diet, drinking clean water, exercising regularly, brushing teeth, getting enough sleep).
- define balanced diet and explain its components using a food pyramid.
- identify common food sources included in a balanced diet (e.g. fruits, vegetables, grains, milk, meat group).
- understand the value of clean drinking water and inquire about the factors that generally make it unclean.
- explore a few ways that can help make water clean and suitable for drinking (water filtration and boiling).

## Resources

- Student's Book pages 48-57
- Workbook pages 20-23
- Cloth/handkerchief/bandana (ask the students to bring this from home)



- Hair ties/elastic bands
- Pictures of keywords (Healthy, Sick, Precaution, Vaccinated, Balanced diet, Exercise, not following SOPs etc.).
- Pictures for the puzzle (cut them up)

## Student's Book and lesson ideas

- Welcome the students into the class and ask them to sit at their tables.
  - Ask them how they are feeling today and explain that in this lesson, they would be talking about their bodies and how to stay healthy.
  - Discuss some of the symptoms of illnesses e.g. high temperature, coughing, rashes etc., and ask if they have ever experienced them and how they made them feel.
  - Keeping in mind the multiple Covid-19 waves, ask them what they do to prevent contagious diseases e.g. wearing masks, social distancing, vaccinations, etc.
  - Discuss if they know anyone who had a contagious disease, what did they do and how did they recover.
  - Highlight the importance of a healthy diet and lifestyle as well as observing SOPs.
- Welcome the students into the class and ask them to sit at their tables.
  - Ask the students to take out the cloth/bandana/handkerchief and hair ties they had gotten from home (inform them a day before to bring the materials).
  - Guide the students in making their own face masks using the instructions below:

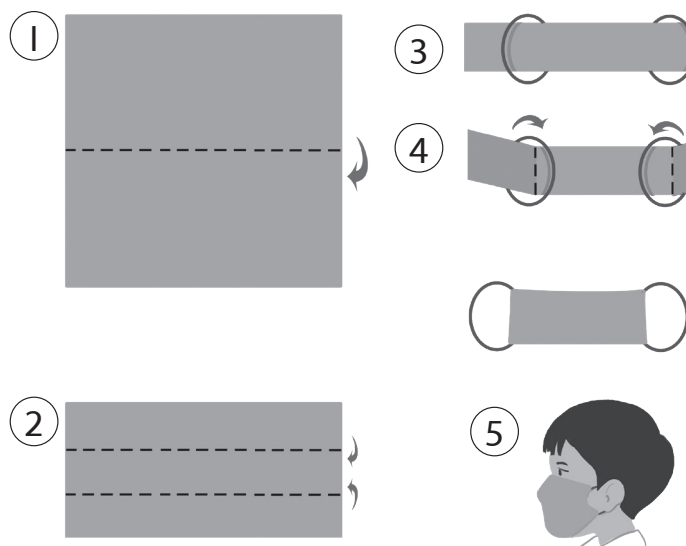

- Explain to them the difference between a cloth mask and a surgical/medical mask.

- 3.**
  - Welcome the students into the class and ask them to sit at their tables.
  - Put up 3-4 pictures on the board each highlighting different keywords (e.g., Healthy, Sick, Precaution, Vaccinated, Balanced diet, Exercise, not following SOPs etc.).
  - Ask the students to say what they think the pictures mean and represent.
  - Briefly name the actual keyword and explain.
  - Have a discussion on each of the pictures.
  
- 4.**
  - Welcome the students into the class and ask them to sit at their tables.
  - Recall what they had discussed in the previous classes and ask the students what they think is meant by “good hygiene.”
  - Call the students to the blackboard, one-by-one, and brainstorm ways of maintaining good hygiene.
  - Emphasize on the importance of clean water and discuss how we get water in our homes and how to clean it.
  
- 5.**
  - Welcome the students into the class and ask them to sit at their tables.
  - Ask students to recall the things needed by plants and animals to survive (e.g. water, food, air , energy, etc.).
  - Explain that humans get their energy from food and that there are different kinds of foods i.e. foods that help us stay healthy (e.g. vegetables, fruit, fish, oats, etc.) and food that makes us sick (e.g. junk food).
  - Explain that we need to eat a balanced diet of carbohydrates, proteins, fats, vitamins and minerals in order to stay healthy.
  - Write these words on the blackboard and ask students to read them aloud together.
  - Divide the students in groups of 4-5 and ask them to look up the definition of the five components from the book or a dictionary.
  - After they are done, ask them to share their definitions and draw some foods that have these in them.
  - Cut out the food drawings and paste them to a chart paper.
  - Write the definition of each component with the pictures.
  - Paste the chart paper/s in the classroom to display.
  
- 6.**
  - Welcome the students into the class and ask them to sit at their tables.

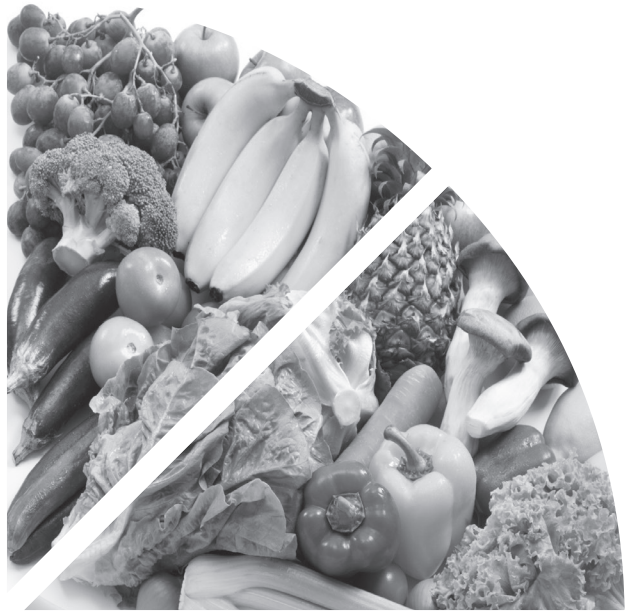

- Divide the class into 6 groups sitting in a circle.
- Hand them a puzzle to solve to get the final image.
- Discuss the image and what it entails (e.g., the importance of a balanced diet, avoiding too much junk food etc.).
- Suggested images as given on page 23.

## Activities

- Arrange the students in groups or individually and read aloud the activities. Follow the instructions given in the Student's Book and Workbook.
- Help the students answer the questions from "In your notebook" and "Learning is fun" etc. Remind them that all the answers are in the Student's Book.

## Workbook steps

Help the students solve answers and activities in the Workbook. They may do these individually in class or as homework or they may work in groups of 2-3. After completing each task from the workbook, students may compare their answers and check their answers with each other.

## STUDENT'S BOOK ANSWERS

### In your Notebook (pg 52)

Your body required protein because your muscles and organs are largely made up of protein. Eating food that is rich in protein helps these parts of your body to grow and stay healthy as well as work properly with the help of amino acids that make up protein.

List some foods that contain proteins e.g. eggs, rice, beans, red meat etc. and if you eat them.

### In your Notebook (pg 54)

The 2 types of carbohydrates are simple carbohydrates and complex carbohydrates. Complex carbohydrates are better to eat if you want lasting energy because they are starches and the body takes longer to digest them. Answer how many times do you eat this type of carbohydrate every day, students may support this with examples.

### In your Notebook (pg 55)

1. Minerals come from the ground and from water. They are absorbed by plants and consumed by animals. We get these minerals when we eat the plants or meat that contains them. Vitamins are made by plants and animals. Plants create all the vitamins they need to survive but animals need to eat plants and other animals to get all the vitamins they need.
2. Your body needs minerals and vitamins to stay healthy and carry out different functions. Give examples of foods that contain minerals and vitamins and how they help the body e.g. milk has calcium (a mineral) and helps strengthen bones and teeth, oranges have vitamin C and helps fight off diseases etc.

## Learning is Fun! (pg 57)

Good hygiene is keeping clean. It is important to keep bodies and clothes clean because dirty bodies attract germs and diseases. So, a clean body is a healthy body. Suggest five ways to maintain good hygiene e.g. washing hands regularly, treating cuts and grazes, changing clothes everyday etc.

## WORKBOOK ANSWERS

### Circle the correct answer

1. B    2. C    3. A    4. C    5. D    6. B    7. C    8. A    9. D    10. B

### I. Look at the different foods. Match them to their type.

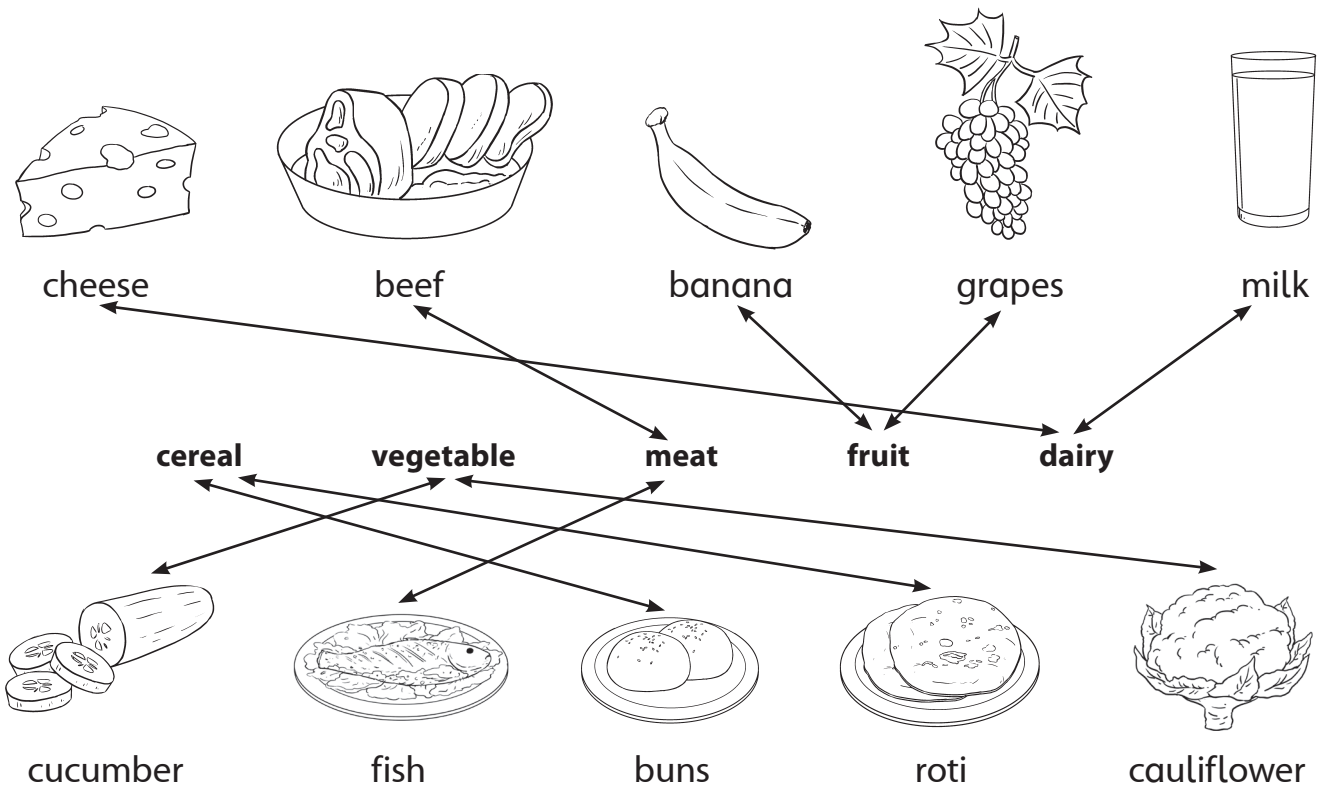

### Food that adds up

- |                     |                           |
|---------------------|---------------------------|
| 1. Amino acid (210) | 6. They absorb them (162) |
| 2. Protein (50)     | 7. Calcium (560)          |
| 3. Sugars (900)     | 8. Vitamin C (444)        |
| 4. Starches (320)   | 9. Brain (60)             |
| 5. Carrots (66)     | 10. Fish (95)             |



# UNIT 4 MATTER AND ITS CHARACTERISTICS

## Background

This unit builds on describing matter, its states and their respective characteristics and properties. The unit also identifies the properties of metals and relates them to its uses. Use the activities in this guide as well as the Student's Book and Workbook to make your lesson enjoyable. They will also help to strengthen and reinforce these concepts.

## Learning outcomes

Students should be able to:

- describe matter and its states.
- describe characteristics of each state of matter with examples.
- compare and sort objects and materials on the basis of physical properties (e.g. mass, volume, states of matter, ability to conduct heat or electricity, ability to float or sink in water).
- explore the properties of metals (i.e. appearance, texture, colour, density).
- identify properties of metal (conducting heat and electricity) and relate these properties to use of metals (i.e. a copper electrical wire, an iron cooking pot).

## Resources

- Student's Book pages 58- 66
- Workbook pages 24-28
- Balloons
- Piece of wood
- 2 cups (paper/thermophore and plastic/ceramic/metal)
- Hot water and normal water

## Student's Book and lesson ideas

1.

- Welcome the students into the class and ask them to sit at their tables.
- Ask students to keep their stationery boxes and water bottles on the desk.
- Ask them about the material and what kind of matter these objects are.
- Also show a balloon and tell the students about Gas.

- Breathe in and out deeply and explain the movement of gases.
- Write the states of matter on the blackboard and ask 3 students to volunteer and come on the board to draw their molecular diagrams.
- Discuss the different properties and examples and also compare the three states of matter.

## 2.

- Welcome the students into the class and ask them to sit at their tables.
- Recall the 3 states of matter and their properties.
- Ask the students to draw 3 solids, liquids and gases, each in their notebooks and label them. These can be things they see in class or otherwise.
- Ask them to list all the properties of each state i.e. (tsf tg 4 pg 46)
- Demonstrate the concepts of conductivity of heat by using 2 cups (one paper/thermophore and one plastic/ceramic/metal) and hot water. Pour water in both the cups simultaneously and ask students to feel the cups one by one.
- Demonstrate the concepts of density and the ability to float/sink in water by using a balloon and a piece of wood and putting it in a tub full of water.

## 3.

- Welcome the students into the class and ask them to sit at their tables.
- Show a 2–3-minute video on metals (e.g., the melting of iron, making of jewelry etc.).
- After the video is shown, ask the students to share their observations.
- Ask students to name 6 things in class that are metals and non-metals (3 each).
- Make a collective list on the blackboard for each category.
- Ask the students why they think these items are metals/non-metals i.e., why they classified each item in each category.
- Discuss the properties of both metals and non-metals, building on what the students already knew and answered.

### Activities

- Arrange the students in groups or individually and read aloud the activities. Follow the instructions given in the Student's Book and Workbook.
- Help the students answer the questions from "In your notebook" and "Learning is fun" etc. Remind them that all the answers are in the Student's Book.

### Workbook steps

Help the students solve answers and activities in the Workbook. They may do these individually in class or as homework or they may work in groups of 2-3. After completing each task from the workbook, students may compare their answers and check their answers with each other.

## STUDENT'S BOOK ANSWERS

### In your Notebook (pg 59)

1. The 3 states of matter are solid, liquid and gas.
2. Atoms are tiny particles. Everything in the world is made of matter, and all matter is made of atoms.
3. Mass is the amount of matter an object has.
4. Volume is the amount of space the matter takes up.

### How much do you remember? (pg 63)

1. Liquid
2. Gas
3. Solid

### Learning is Fun! (pg 66)

1.

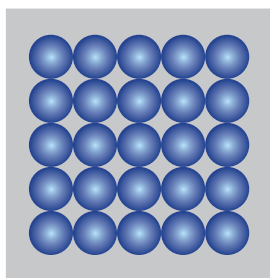

Particles in a solid are packed tightly together and can't move. That means solids have the same shape no matter where you put them.

Trees, feathers, leaves, salt, sugar are all examples of solids.

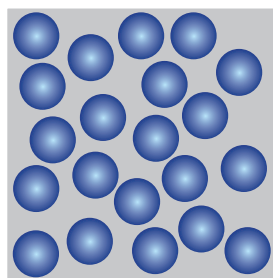

Particles in a liquid are not packed as tightly together as in a solid. They have space to move around. That means they can change shape according to the container they are in.

Water, juices, tears, sweat, and saliva are examples of liquids.

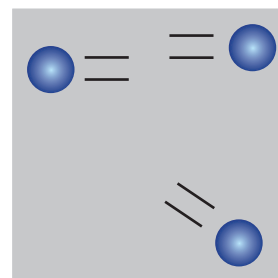

Particles in a gas have a lot of space between them. This means they can move quickly and freely through the air.

The Air composed of gases such as oxygen, helium and carbon dioxide are all examples of gases.









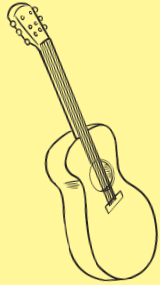

2. Volume is the amount of space the matter takes up. Mass is the amount of matter an object has. Density is the mass of an object in a specific volume. Insulators are materials that do not allow electricity or heat to pass through it.
3. The following properties of metals are useful because:
  - Lustre: it gives a shiny appearance to the metal. Some metals are valued for their appearance and used in jewellery.
  - High melting point: it may be used in machinery and other processes that require a lot of heat as the metal won't change its state.

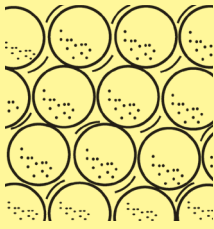

- Conductivity: some metals, such as copper and silver are very good conductors and may be used as electricity and telecommunications wires. Copper is also used to make cooking utensils due to its ability to conduct heat.
- Malleability: most metals don't change shape easily due to which they are used in many processes and machines etc.

## WORKBOOK ANSWERS

### Solids, liquids and gases

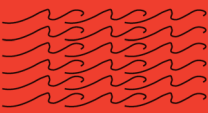
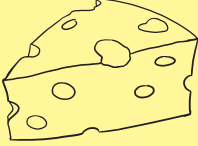
liquid	solid	This has no fixed shape but has a definite mass and volume.			When it fills a container, it spreads evenly.
This has no fixed shape or volume.	gas	has a definite shape, mass, and volume		can be poured	
		blood	takes the shape and size of its container		Things take this form when they freeze.
takes the shape of the container but not the size		Atoms are tightly packed.	It flows.		It's all around but you can't see it.
	Solids take this state when they melt.				Liquids take this state when they evaporate.

## Fill in the blanks

1. Atoms
2. Solid, liquid, gas
3. Volume
4. Mass
5. Liquids, gases
6. Gas
7. Air, clouds
8. Liquid
9. Milk, juice
10. Solid
11. Ice, chair
12. Gas

## Matter quiz

11. C
12. B
13. B
14. D
15. B
16. D
17. B
18. B
19. A
20. B

## Matter crossword

### Across

2. Atoms
4. Shape
5. Volume
9. Carbon dioxide
10. Ice
11. Solid
12. Mass

### Down

1. Water vapour
3. Gas
4. Snow
6. Liquid
7. Oxygen
8. Petrol
9. Container



# UNIT 5 FORMS OF ENERGY AND ENERGY TRANSFER

## Background

This unit builds on the identification of energy, its sources, uses and transformation. The unit emphasizes the importance of energy conservation. It also relates to different physical phenomena to the behavior of light, sound and electricity. Use the activities in this guide as well as the Student's Book and Workbook to make your lesson enjoyable. They will also help to strengthen and reinforce these concepts.

## Learning outcomes

Students should be able to:

- identify sources of energy (e.g. Sun, flowing water, wind, coal, oil, gas).
- recognize that energy is needed to do work (e.g. for moving objects), heating and lighting.
- describe and demonstrate the transformation of energy.
- understand the importance of energy conservation.
- recognize the role and responsibility of humans to conserve energy resources.
- relate familiar physical phenomena (i.e., shadows, reflections, and rainbows) to the behaviour of light.
- relate familiar physical phenomena (i.e., vibrating objects, echoes) to the production and behaviour of sound.
- recognize that warmer objects have a higher temperature than cooler objects.
- investigate the changes that occur when a hot object is brought in contact with a cold object.
- identify ways to measure temperature, and understand its units.
- describe and demonstrate that electrical energy in a circuit can be transformed into other forms of energy (e.g. heat, light, sound).
- explain and provide reasoning that a simple electric circuit

## Resources

- Student's Book pages 67-79
- Workbook pages 29-35
- Mirror and glass
- White cardboard sheet
- Torch
- Prism

- Toy drum
- Small ball

## **Student's Book and lesson ideas**

### **1.**

- Welcome the students into the class and ask them to sit at their tables.
- Write the keyword ENERGY on the blackboard and ask the students to name types of energy they observe and know about.
- Play a 2–3-minute video on the sources of energy e.g., windmills, dams, solar panels, oil and gas, coal and wood burning etc. and discuss the differences between renewable and non-renewable energy resources.
- Discuss ways to conserve energy and ask students if they do any of them.

### **2.**

- Welcome the students into the class and ask them to sit at their tables.
- Show the students a mirror and a glass. Ask them what they see in each.
- Discuss light and reflection and why you can see in a mirror but not in a normal glass.
- Ask the students to hold out their hands in front of them over a piece of paper and ask them if they can see a shadow? Ask them to move their hands around (tilt and move it up and down) and see the shadow change.
- Discuss how shadows are formed and how their size and positions change.
- Turn off the light in the classroom and place a white cardboard sheet on the table. In the centre, place a prism.
- Use a torch to pass light through a prism and see the rainbow colours appear on the white cardboard sheet. Similarly, show a beam of light as well as shadow.

### **3.**

- Welcome the students into the class and ask them to sit at their tables.
- Bang the toy drum and explain how sound is produced and travels.
- Ask students to recall if they have ever heard any echoes and discuss why this happens.
- Use a small ball to play catch and throw and introduce energy through motion.

### **4.**

- Welcome the students into the class and ask them to sit at their tables.
- Show a 2–3-minute video on how electricity is produced and how it works in our homes.
- Draw a simple circuit on the board and ask what happens if the switch is opened vs when it is closed.

## Activities

- Arrange the students in groups or individually and read aloud the activities. Follow the instructions given in the Student's Book and Workbook.
- Help the students answer the questions from "In your notebook" and "Learning is fun" etc. Remind them that all the answers are in the Student's Book.

## Workbook steps

Help the students solve answers and activities in the Workbook. They may do these individually in class or as homework or they may work in groups of 2-3. After completing each task from the workbook, students may compare their answers and check their answers with each other.

## STUDENT'S BOOK ANSWERS

### In your Notebook (pg 70)

1. A shadow is formed behind an object when the light hits that object, where the background remains unlit.
2. The size and position of a shadow change according to the position of the light source. If an object is moved closer to the light source, the shadow gets bigger. If an object is moved further away from the light source, the shadow gets smaller. If the light source is on the right of an object, the shadow will appear on the left. If it is to the left of an object, the shadow appears to the right.
3. By using the acronym: VIBGYOR.

### In your Notebook (pg 75)

1. Heat is a type of energy that is produced when particles start moving.
2. Temperature measures how much heat energy an object has. There are two main scales for measuring temperature; Celsius and Fahrenheit.
3. Ice cream melts because heat is transferred from the ice cream to the air.
4. Celsius and Fahrenheit.
5. a. left to right  
b. right to left

### In your Notebook (pg 75)

Inside the glass of the thermometer, is a small thin tube containing mercury. When mercury is cold, its particles stay close together. This means it does not take up much space and stays near the bottom of the thermometer. As the temperature of the thermometer increases, the particles of mercury begin to spread out and take up more space. This causes it to move up the thermometer to find more room. The hotter the temperature, the higher the mercury travels up the tube. The cooler the temperature, the lower the mercury in the tube stays.

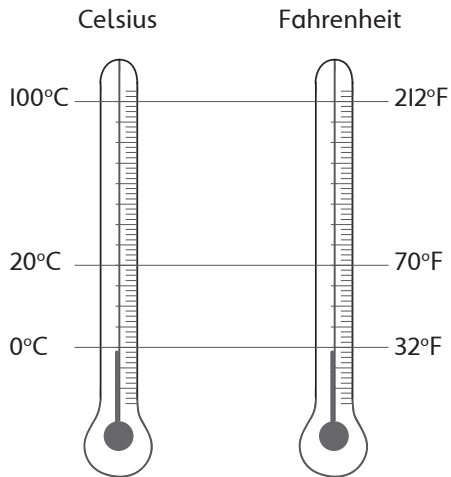

## WORD FIND

Can you find six words that have to do with heat, light, and sound in the square below?

R	S	H	A	D	O	W	L	O	T	D	R	Z
W	U	P	Q	F	R	E	E	Z	E	E	S	Q
A	I	S	H	A	D	I	L	U	R	C	A	P
P	S	H	E	R	T	Z	Q	C	I	I	I	B
A	L	F	R	E	E	A	L	E	O	B	L	O
H	E	B	O	I	P	X	A	D	B	E	E	I
S	C	O	P	O	X	N	O	T	E	L	C	L

boil

decibel

celsius

note

shadow

freeze

### In your Notebook (pg 77)

- The flow of electricity is known as current electricity. To create current electricity, scientists and inventors have invented ways to get electrons to move between atoms e.g. by sending it along wires to where the electricity is needed.
- a source of electrical energy like a battery
  - wires for the electricity to travel along
  - something to convert the electricity into heat or light (e.g. a light bulb)
  - a switch to turn the circuit on and off

3.

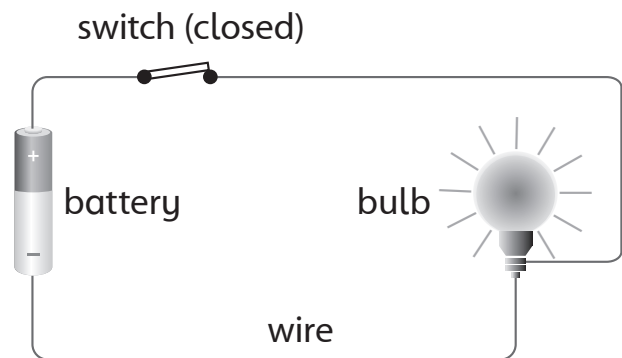
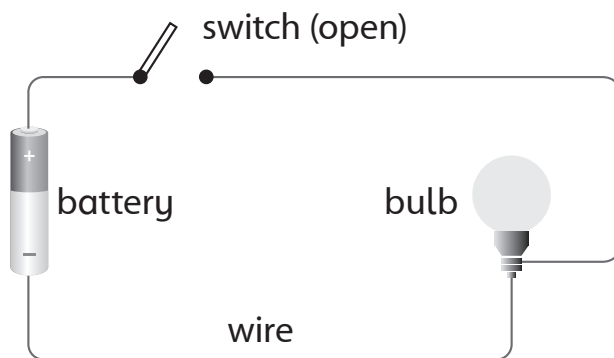

### In your Notebook (pg 79)

Energy can be transformed from one form to the other. E.g. when we press the doorbell button, we complete the circuit which provides electricity to a small hammer which hits the bell to make a sound. In this way, the electrical energy is converted or transformed to sound energy. Or when we press the switch to turn on a bulb or a heater, we are actually completing the circuit which provides electricity to the devices that give us light and heat. Here the electrical energy is transformed to light and heat energy.

### Learning is Fun! (pg 79)

1. Because electricity requires a complete path to flow from its source to its destination.
2. Using a thermometer.
3. The Celsius scale is named after a Swedish scientist, Anders Celsius. He lived about 300 years ago and developed the Celsius scale we use today. The Fahrenheit scale is named after a Polish-born scientist, Daniel Gabriel Fahrenheit, who also lived about 300 years ago. He invented the thermometer and developed the Fahrenheit scale.

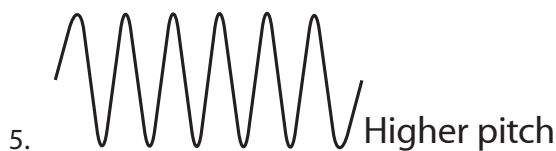
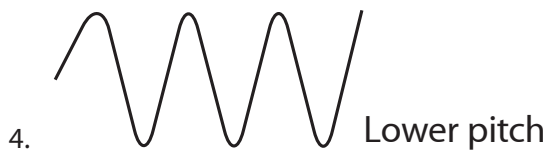

6. a. Sounds can be heard.  
b. Sounds travel from one place to the other.  
c. Low sounds have a larger gap between each wave than high sounds.

## WORKBOOK ANSWERS

### Types of energy

1. Kinetic/gravitational energy
2. Heat/ light energy
3. Heat energy
4. Kinetic energy
5. Heat/electrical energy
6. Kinetic /gravitational energy
7. Heat energy

### Sound wordsearch

Find the names of things related to sound in the wordsearch below.

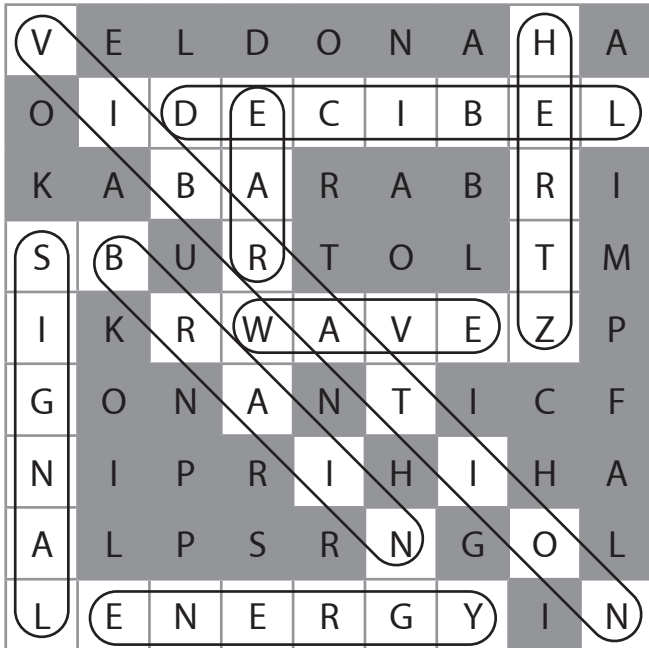

vibration  
decibel  
brain

ear  
hertz  
energy

wave  
signal

### About echoes

1. They will hear an echo. An echo is when the same sound is heard more than once. Echoes occur when sound waves are reflected or bounced off a surface, in this case, the walls/floor of the canyon.
2. When sound hits a soft surface, most of the sound is not reflected; it is absorbed. So, if the bottom is covered in cushions, either no sound would be reflected, or very little i.e., it would not be a very clear/loud echo.
3. If the canyon were much shorter, the echo would either not be produced or be very faint. The distance between a surface and where a sound starts, plays an important part in the echo, as to produce an echo, the sound should not start too close to the surface.



## Energy transfer

1. A
2. A
3. C
4. B
5. A

## Taking temperature

1. 20
2. 0
3. 100
4. 85

## Circuits

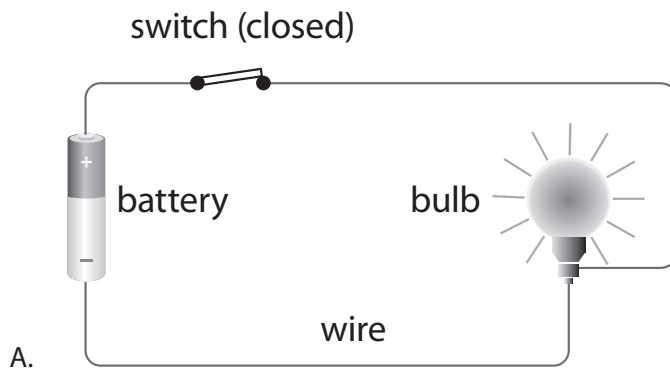

- B.
1. Energy
  2. Wires
  3. Current
  4. Battery
  5. Wet

# UNIT 6 FORCES AND MOTION

## Background

This unit builds on what is force and motion and identifies the types of force. This unit tells you how machines can easily be used with motion and how important machines are in our lives. Use the activities in this guide as well as the Student's Book and Workbook to make your lesson enjoyable. They will also help to strengthen and reinforce these concepts.

## Learning outcomes

Students should be able to:

- describe force and motion with examples from daily life.
- identify gravity as a force that draws objects to Earth.
- investigate that frictional force works against the direction of motion.
- provide reasoning with evidence that friction can be either detrimental or useful under different circumstances.
- recognize that simple machines (e.g. levers, pulleys, gears, ramps) help make motion easier (e.g. make lifting things easier, reduce the amount of force required, change the distance, or change the direction of the force).

## Resources

- Student's Book pages 80-89
- Workbook pages 36-40
- Ball, bat, and a clay
- 2 Toy cars (1 big and 1 small)

## Student's Book and lesson ideas

1.
  - Welcome the students into the class and ask them to sit at their tables.
  - Explain what is force and what can it do.
  - Ask them to bring a ball, bat, and clay.
  - Demonstrate to them that by using force, you can catch the ball, hit it with a bat, and change the shape of the clay.
  - Ask them if they ride bicycles. If they say yes, tell them how they can pedal faster using force and how they use brakes to stop the cycle.

- Explain the difference between a pulling force and a pushing force and tell the student to give one example.
- Tell the student to throw the pencil upwards, if it comes down, explain to them it is due to the force of gravity.
- Ask the students to drop a pencil and a piece of paper from an exact height. Ask them which object fell faster and why?
- Perform the experiment and explain that they both fall at the same time because, despite their different masses, gravity causes them to move at the same rate when air resistance is not there.

## 2.

- Welcome the students into the class and ask them to sit at their tables.
- Explain them what friction is. Tell them how they walk and write with a pencil using friction. Ask them more examples of how friction is important for us.
- Use the small toy car to demonstrate that friction can be good if it helps control the movement (fast or slow). It can be harmful if it doesn't allow anything to move or block it.
- Use a sloped area and the toy car to explain to them how slippery and wet surfaces can be considered bad friction. Tell them how driving in the rain can be dangerous as you can't move with bad friction.
- Then repeat both the demonstrations with a big car and describe how an object's size, shape, and mass affect its friction.

## 3.

- Welcome the students into the class and ask them to sit at their tables.
- Recall the concept of force and friction.
- Ask the students what they think a simple machine is. Tell the students that a simple machine is a tool that makes work easy. Ask for examples of simple machines they have seen in their daily life.
- Ask the students to make a simple lever on their desks using their scale and a pencil. Follow up by asking them the following questions:
  - How many hands or fingers do you need to lift the stack of books by yourself?
  - How many hands or fingers do you need to lift the stack of books when using the ruler and pencil as a lever?
  - Does it feel easier or more difficult to lift the stack of books, when using the lever instead of lifting them by yourself?



## Activities

- Arrange the students in groups or individually and read aloud the activities. Follow the instructions given in the Student's Book and Workbook.
- Help the students answer the questions from "In your notebook" and "Learning is fun" etc. Remind them that all the answers are in the Student's Book.

## Workbook steps

Help the students solve answers and activities in the Workbook. They may do these individually in class or as homework or they may work in groups of 2-3. After completing each task from the workbook, students may compare their answers and check their answers with each other.

## STUDENT'S BOOK ANSWERS

### In your Notebook (pg 81)

1. Gravity is the force that keeps us on Earth. It is the force that makes sure what goes up, must come down. If you jump into the air, gravity makes sure you come back down.
2. The Earth's force of gravity keeps everything on the ground. Even when objects are tossed into the air, they are pulled back down towards the centre of the Earth.

### In your Notebook (pg 84)

1. Friction is the force that is produced when two surfaces rub together. It is the force that slows or stops objects that are sliding past each other. For example, you need friction to walk and write. Friction between your feet and the road stop them from skidding and the pencil lead leaves marks on paper due to friction (other examples may also be used by the students).
2. Air resistance is a type of friction. Instead of having one object rubbing against another to slow it down, the air slows the object down. For example, if you walk with the wind coming towards you, it is harder than walking with the wind coming from behind you. This is because of air resistance. Parachutes work because of air resistance. A parachutist falls slowly because the air pushes against the parachute. The air resistance slows down the falling parachute (other examples may also be used by the students).

### Learning is Fun! (pg 89)

1. Gravity is the force that keeps us on Earth. It is the force that makes sure what goes up must come down. If you jump into the air, gravity makes sure you come back down. The Earth's force of gravity keeps everything on the ground. Even when objects are tossed into the air, they are pulled back down towards the centre of the Earth.
2. Because there is less friction due to which you may slide or slip.

3. A lever is a simple machine that can lift objects with little effort. It has an arm that rests on, or is attached to a point known as a fulcrum. When pressure is put on one end of the lever, the other end moves an object that would normally be very hard to move.



4. An inclined plane is a flat surface that joins one level with a higher level. Inclined planes are used to move objects from a lower level to an upper level. It works by allowing someone to roll or slide a heavy object, rather than having to lift it.
5. A wedge is two inclined planes joined together. With a wedge, the pointed edge surface is used to split or cut things apart. For example, a chisel is a wedge that cuts wood, an axe head is also a wedge.
6. The screw works like an inclined plane. When you twist a screw into a piece of wood, the wood moves along the screw. This is just like an object being rolled up an inclined plane. A screw is used to hold objects in place.
7. Gears are wheels with teeth that can either increase the speed of a machine or its force. One gear can make another one turn faster, but it can also make it turn in a different direction.
8. Wheel and axle, because they both move together. When one is turned, the other turns as well, making movement easier, or in this case unlocking the door.
9. Pulley.

## WORKBOOK ANSWERS

Which force is being used?

1. F
2. A
3. F
4. G
5. A
6. A
7. F
8. G

9. G

10.F

11.G

### **Push or pull?**

1. Pull
2. Push
3. Push
4. Push
5. Push
6. Pull

### **Which force?**

1. a. ii  
b. i  
c. iii  
d. ii
2. a. by decreasing the inclined plane's tilt/by flattening the inclined plane  
b. by kicking it  
c. by pedaling slower/ by not pedaling contently  
d. by hitting it with the bat

### **Which tools and machines would you use?**

1. Wedge
2. Wedge
3. Screw
4. Wheel and axle
5. Lever/pulley

### **Force, tools, and machines quiz**

- |      |         |      |      |      |
|------|---------|------|------|------|
| 1. B | 2. C, D | 3. B | 4. D | 5. A |
| 6. D | 7. D    | 8. B | 9. A |      |



# UNIT 7 EARTH AND ITS RESOURCES

## Background

This unit demonstrates the importance of Earth to have life. It explains resources and the many resources available to us i.e., renewable or non-renewable. Moreover, this unit also introduces the idea of conservation as an essential process to sustain resources. Use the activities in this guide as well as the Student's Book and Workbook to make your lesson enjoyable. They will also help to strengthen and reinforce these concepts.

## Learning outcomes

Students should be able to:

- recognize that Earth's surface is made up of land and water and is surrounded by air.
- recognize that water in rivers and streams flows from mountains to oceans or lakes.
- identify some of earth's natural resources that are used in everyday life (e.g., water, wind, soil, forest, oil, natural gas, minerals).
- recognize that some remains (fossils) of animals and plants that lived on Earth, a long time ago, are found in rocks, soil, and under the sea.
- differentiate between renewable and nonrenewable resources, and explain the importance of conservation.
- suggest the ways to conserve the natural resources.

## Resources

- Student's Book pages 90-98
- Workbook pages 41-46
- Colored papers
- Chart papers, cotton, craft papers, glitter, crayons, beads, etc.
- Pictures of resources on flashcards

## Student's Book and lesson ideas

1.

- Welcome the students into the class and ask them to sit at their tables.
- Write the words given below for students to unscramble on the board:

W T R A E

(WATER)

T O F S E R

(FOREST)

C A L G R E I

(GLACIER)

H L G I T

(LIGHT)

R E T A H

(EARTH)

L R U N T A A

(NATURAL)

- Ask the students to make a 3Rs chart on colored papers, i.e., Recycle, Reuse, and Reduce.
- Explain how important these three Rs are for saving the Earth and ask them to stick their papers in their notebooks.
- Tell the kids to think of 5 Earth activities to help take care of the Earth, i.e., clean the Earth by trashing stuff in the bin, plant trees, help animals, turn off lights when you go out, recycle, etc.
- Ask them how many of these they actually do.

## 2.

- Welcome the students into the class and ask them to sit at their tables.
- Tell them how important it is to save water to save the Earth.
- Explain the water cycle and tell them the stages of the water cycle.
- Show videos for evaporation, precipitation, and condensation in the class.
- Divide the students in groups of 4-5 and make the water cycle using chart papers, cotton (for clouds), craft paper (for water) or any other materials the students like to make their diagrams creative.
- Display the posters on a wall in class.

## 3.

- Welcome the students into the class and ask them to sit at their tables.
- Demonstrate the concept of resources and tell them what natural resources are.
- Show 5-6 pictures on flashcards and ask students to guess the resource shown.
- Discuss the shown resources and their importance and uses.
- Ask the students to picture themselves in their favourite park. What do they see? Ask the number of resources.
- Identify and classify renewable resources and non-renewable resources, as well as natural resources and man-made resources.
- Explain the concept of conservation to the students and why it is important to us.
- Show a 2–3-minute video to explain this concept further.

## Activities

- Arrange the students in groups or individually and read aloud the activities. Follow the instructions given in the Student's Book and Workbook.
- Help the students answer the questions from "In your notebook" and "Learning is fun" etc. Remind them that all the answers are in the Student's Book.



## Workbook steps

Help the students solve answers and activities in the Workbook. They may do these individually in class or as homework or they may work in groups of 2-3. After completing each task from the workbook, students may compare their answers and check their answers with each other.

## STUDENT'S BOOK ANSWERS

### In your Notebook (pg 91)

1. Rain falls from the sky but it begins as water on Earth. Water vapour rises into the air and later falls back as rain onto the Earth. There are four stages of the water cycle:
  - evaporation
  - condensation
  - precipitation
  - run-off (or collection)
2. A river is the natural flow of water that continues in a long line across the land to the sea. Water flows from a higher level, such as a mountain to a lower level, such as a valley or plain, forming a river. Flowing water flows downhill as small creeks first. Small creeks combine to form larger streams and rivers as they flow downhill. A glacier is defined as a slow-moving mass or river of ice, formed from snow on mountains or near the North Pole or South Pole. They are made up of are made up of fallen snow that, over many years, compresses into large, thickened ice masses. Glaciers move very slowly, whereas rivers flow very fast.

### In your Notebook (pg 93)

1. Natural resources are things that grow or are created naturally, without human help.
2. List any three natural resources and how they are used by humans e.g. water is used for drinking, washing, energy production etc., salt is used for cooking, science experiments etc. and so on.

### In your Notebook (pg 98)

1. Conservation is about protecting and managing the Earth's natural resources and environment.
2. Conservation is needed so that the Earth's natural resources and environment are still here for future generations.
3. Discuss if water conservation helps or does not help people living in dry, desert areas. Students may support their claims using examples

## WORKBOOK ANSWERS

Precipitation: 2

Condensation: 3

Evaporation: 1

## The water cycle

1. Heated, sun
2. Rising
3. Cooling, clouds
4. Rain
5. Ocean

## Natural resources or not?

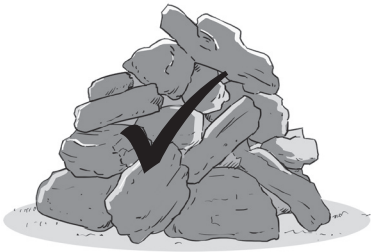
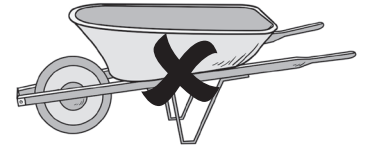
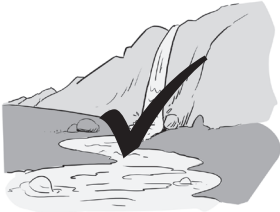
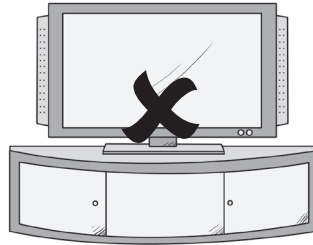

coal

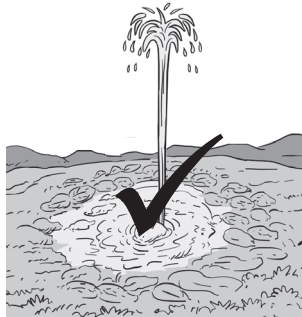

oil



1. B, C
2. B
3. D
4. C
5. B

**What is it for?**

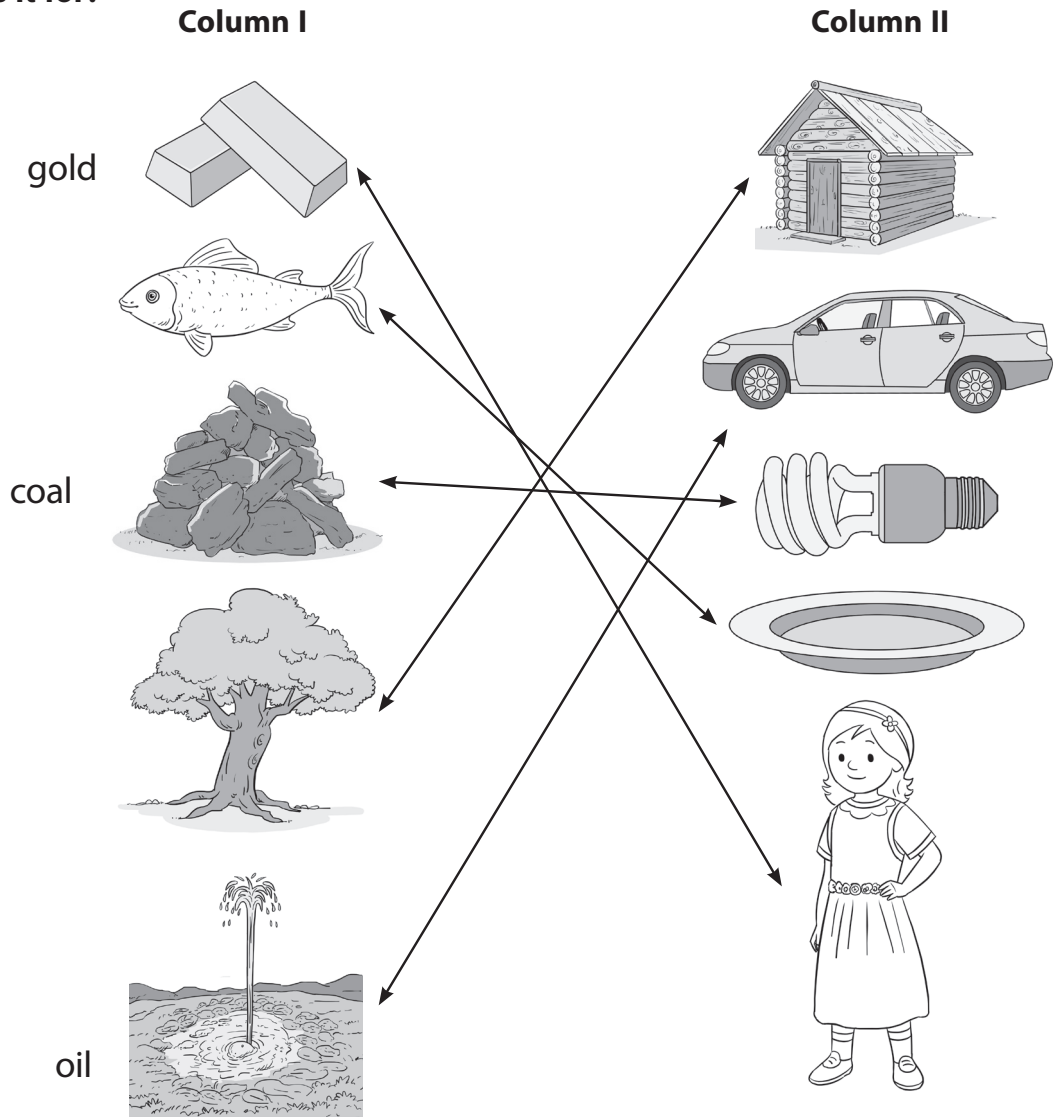

**II. Across**

4. Renewable    6. Coal    8. Solar

**Down**

1. Minerals    2. Useful    3. Trees    5. Gold    7. Water

**Renewable or non-renewable?**

Renewable: wind, trees, water

Non-renewable: oil, coal, gas

**Conservation crossword**

**Down**

1. Desert

**Across**

2. Overlogging    3. Conservation

# UNIT 8 EARTH'S WEATHER AND CLIMATES

## Background

This unit explains what different weathers are like and what kinds of things we do in that weather. This unit also covers the difference between weather and climate and how the sun's direction can determine climate. Use the activities in this guide as well as the Student's Book and Workbook to make your lesson enjoyable. They will also help to strengthen and reinforce these concepts.

## Learning outcomes

Students should be able to:

- understand the difference between weather and climate.
- relate weather (i.e. daily variations in temperature, humidity, precipitation in the form of rain or snow, clouds, and wind) changes with changing geographical location.
- recognize that average temperature and precipitation can change seasons and location.

## Resources

- Student's Book pages 99-101
- Workbook pages 47-49
- Globe
- Torch
- Chart paper/wall

## Student's Book and lesson ideas

1.
  - Welcome the students into the class and ask them to sit at their tables.
  - Ask the students to describe today's weather.
  - Explain to them the different types of weathers and what is the first thing they think of when they hear any weather. You can ask them what they do when it is raining or is sunny etc.
  - Ask the students to list things they like to do in summers and winters and to draw little pictures/doodles in front of each activity.

- 2.**
- Welcome the students into the class and ask them to sit at their tables.
  - Using the globe introduce the basic geography of the Earth.
  - Placing a white chart paper on the board or at a wall, ask a student to hold the globe while you shine the torch to help students understand the light that falls on Earth from the Sun and that it is not always the same all around.
  - Ask them how the temperature in summer and winter in their country is and if they know the weather in those seasons in some other country as well.
  - Tell the students to track the Weather for a week and record it in a weather table.
- 3.**
- Welcome the students into the class and ask them to sit at their tables.
  - Explain the difference between weather and climate.
  - Describe the three zones of Earth based on the climate using 2-3 minute videos and what the weathers look like in each zone.

### **Activities**

- Arrange the students in groups or individually and read aloud the activities. Follow the instructions given in the Student's Book and Workbook.
- Help the students answer the questions from "In your notebook" and "Learning is fun" etc. Remind them that all the answers are in the Student's Book.

### **Workbook steps**

Help the students solve answers and activities in the Workbook. They may do these individually in class or as homework or they may work in groups of 2-3. After completing each task from the workbook, students may compare their answers and check their answers with each other.

## **STUDENT'S BOOK ANSWERS**

### **Learning is Fun! (pg 101)**

1. Drinking clean water is an important resource because all living beings need water to live.
2. We should save water because there are places on Earth which have very little rainfall and freshwater, such as the desert Thar. People in such places live a very difficult life trying to find water for daily use.
3. Weather refers to the conditions in the air over a short period of time, while climate refers to the air conditions over a long period of time.
4. Renewable resources are resources that will not run out. Humans can keep using them as much as they like. For example, wind and solar energy are renewable resources as the Earth will not run out of wind or energy from the Sun. Non-renewable resources are resources that can only be used once. Once they have all been used up, there are no more of them. Examples of non-renewable resources are coal, oil, gas,

petroleum, and minerals.

5. Natural resources must be conserved so that they are still here for future generations and don't get too damaged/destroyed or run out.

## WORKBOOK ANSWERS

### Weather and clothes

Match the clothes to the weather when you would wear them.

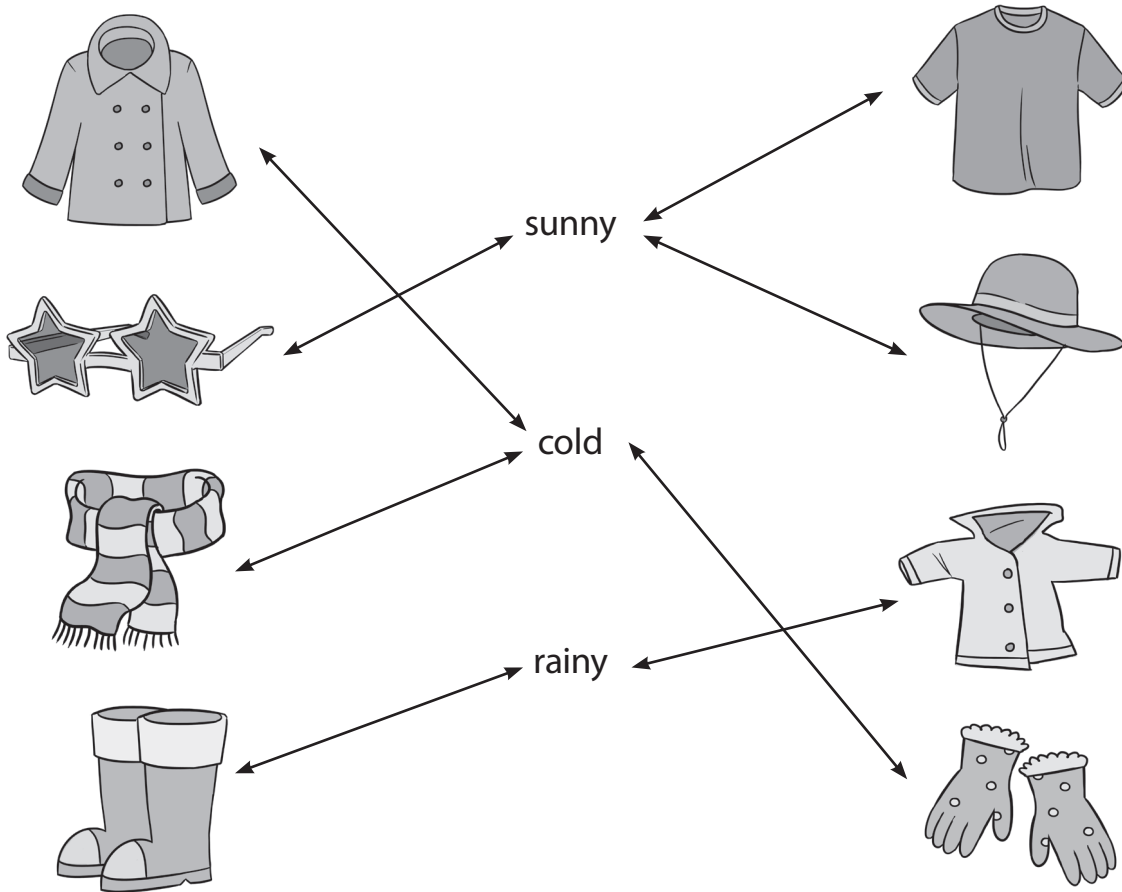

### Weather and climate

1. Precipitation is the term used to describe the amount of rain or snow which falls in an area. Some parts of Earth experience more rainfall (i.e. increased precipitation) than others. This is because they are located near where clouds form, such as coastal regions, and where air in clouds cools, such as mountains.
2. The difference between weather and climate is that weather refers to the conditions in the air over a short period of time, while climate refers to the air conditions over a long period of time.

## Weather

Students can give their own activities, some of the examples are:

1. Play cricket, moisturize skin
2. Go to the beach, eat ice cream
3. Wear warm clothes, drink hot soup
4. Play in the rain, make and sail a paper boat
5. Fly a kite, float a balloon
6. Play tennis, read in open air



# UNIT 9 EARTH IN THE SOLAR SYSTEM

## Background

This unit demonstrates the solar system and how to identify the planets. This unit will also help the students determine how far the planets are from the sun. Moreover, it also builds the concept of the lunar and solar eclipse and how do they occur. Use the activities in this guide as well as the Student's Book and Workbook to make your lesson enjoyable. They will also help to strengthen and reinforce these concepts.

## Learning outcomes

Students should be able to:

- describe and demonstrate the Solar System with planets revolving around the sun.
- identify the sun as a source of heat and light for the Solar System.
- explain how the movements of the Earth cause day and night and the seasons.
- recognize that the earth has a moon that revolves around it, and from earth the moon looks different at different times of the month.
- investigate and describe how day and night are related to Earth's daily rotation about its axis, and provide evidence of this rotation from the changing appearance of shadows during the day.
- describe how seasons in Earth's Northern and Southern hemispheres are related to Earth's annual movement around the Sun.
- illustrate and explain how solar and lunar eclipses occur.

## Resources

- Student's Book pages 102-109
- Workbook pages 50-53
- White paper
- Colored Pencils

## Student's Book and lesson ideas

1.
  - Welcome the students into the class and ask them to sit at their tables.
  - Ask them what a solar system is. Can they list the planets in order?
  - Tell the students to create a phrase or acronym to help them remember the solar system's planets in order.



- 2.**
- Welcome the students into the class and ask them to sit at their tables.
  - Ask them to recall the planets. Tell the students to draw a solar system at home and bring it to class.
  - Tell them to also write a paragraph, describing the planets revolving around the sun and to research about one planet they like and write five interesting facts about it.
  - Tell the students to make up a planet of their own. Draw and colour their planet. What will they name it? Who will live there? What things will it have? How will they protect the environment of their planet? Etc.
- 3.**
- Welcome the students into the class and ask them to sit at their tables.
  - Ask the students about what they have observed about the moon and its monthly changes highlighting the moon sighting and full moon.
  - Explain both lunar and solar eclipse to the students. Show them videos of both lunar and solar eclipses to explain.

### **Activities**

- Arrange the students in groups or individually and read aloud the activities. Follow the instructions given in the Student's Book and Workbook.
- Help the students answer the questions from "In your notebook" and "Learning is fun" etc. Remind them that all the answers are in the Student's Book.

### **Workbook steps**

Help the students solve answers and activities in the Workbook. They may do these individually in class or as homework or they may work in groups of 2-3. After completing each task from the workbook, students may compare their answers and check their answers with each other.

## **STUDENT'S BOOK ANSWERS**

### **Learning is Fun! (pg 109)**

1. The axis is an imaginary line passing through the North and South Poles, dividing the Earth into Northern and Southern hemispheres.
2. The seasons are caused by the tilting of the Earth. This means that some parts of the Earth are positioned closer to the Sun at certain times of the year than other parts, and further away from the Sun at other times of the year.

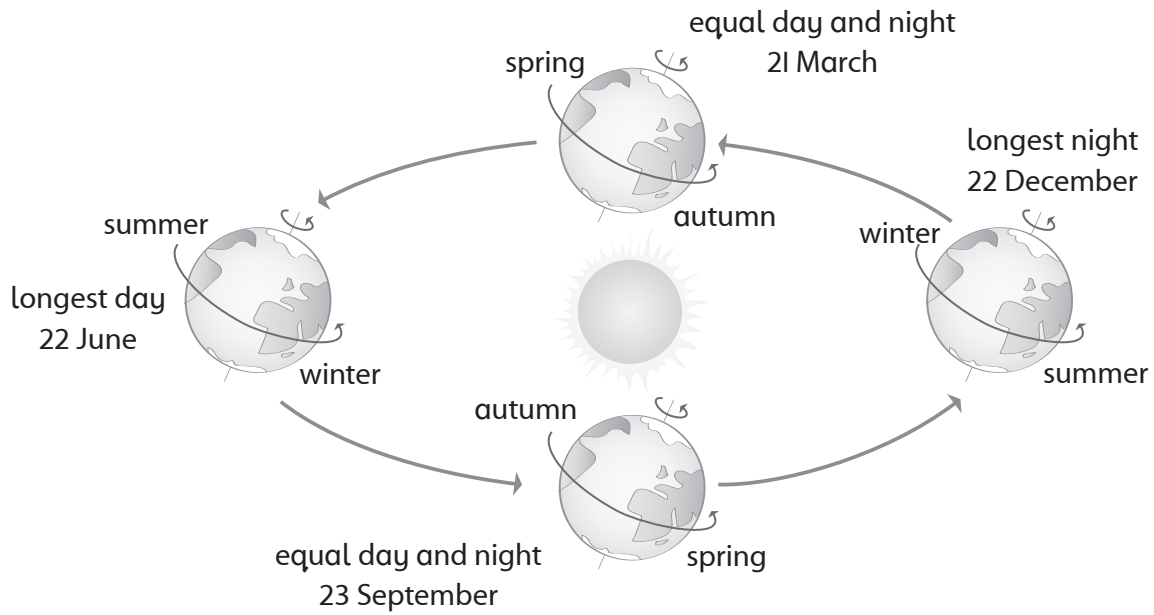

3. Eclipses are caused by shadows. Eclipses occur when a planet, moon, or other celestial object moves between the Sun and another planet, moon or celestial object. Because these bodies are opaque, they stop the sunlight from passing through, and cast a shadow.

Fill in the blanks.

1. Earth      2. Jupiter      3. Mars      4. Mercury

## WORKBOOK ANSWERS

Which planet goes where?

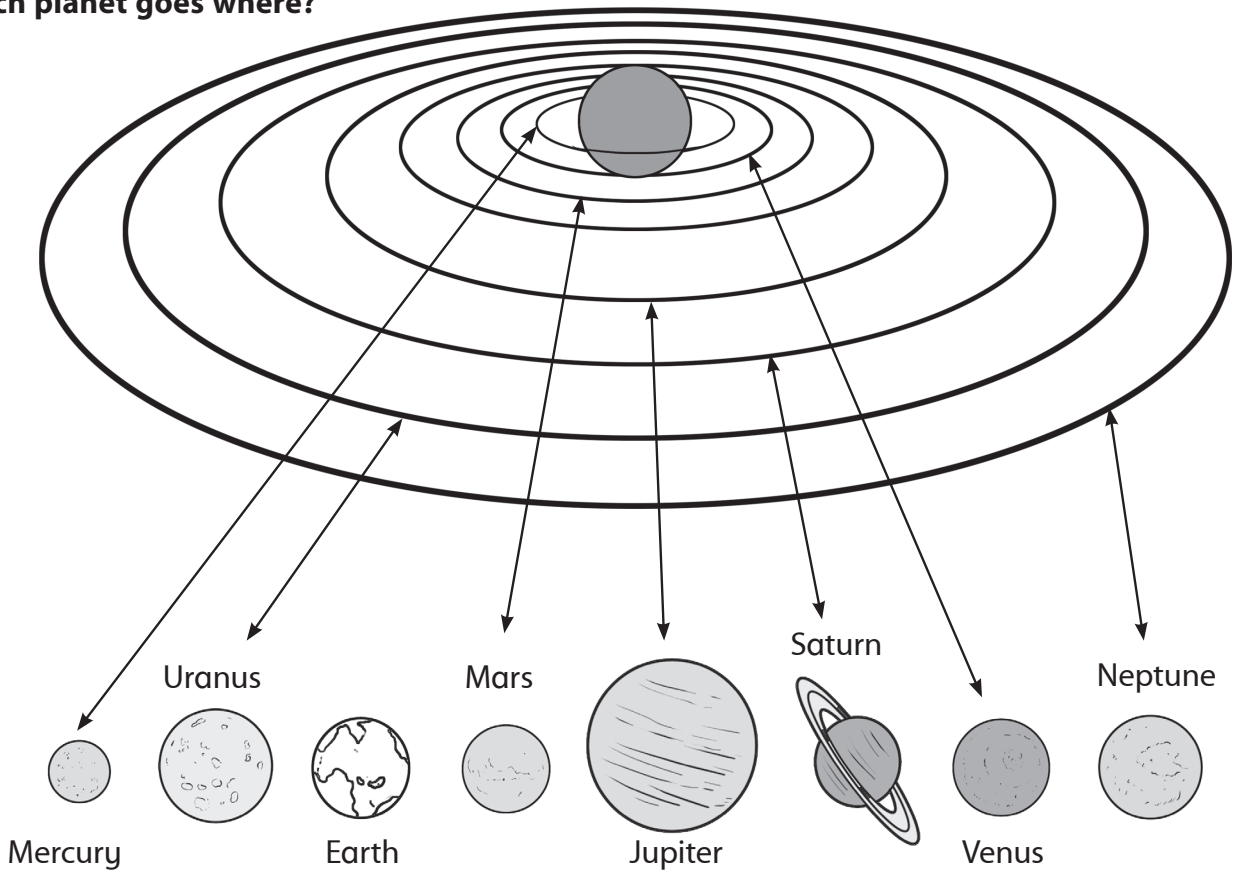

## Light and dark

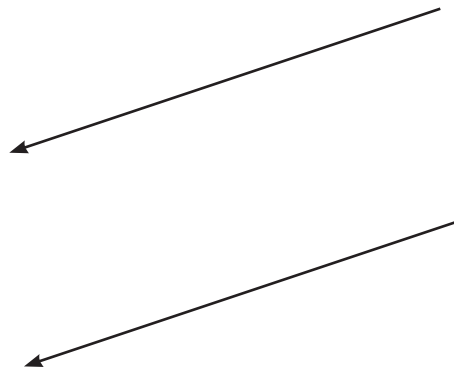

## Eclipses

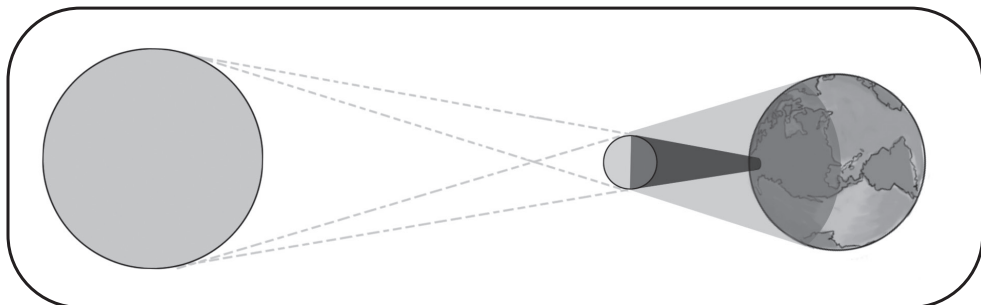
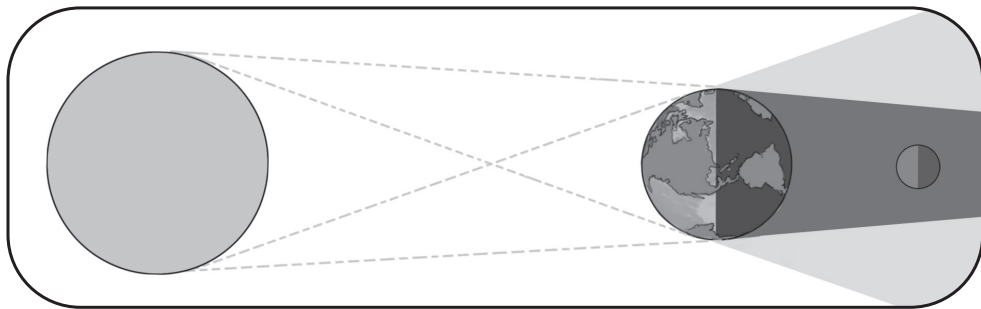



# UNIT 10

# TECHNOLOGY IN EVERYDAY LIFE

## Background

This unit demonstrates how technology has changed our lives and made it better. It will also explore how science and technology can solve everyday problems. Use the activities in this guide as well as the Student's Book and Workbook to make your lesson enjoyable. They will also help to strengthen and reinforce these concepts.

## Learning outcomes

Students should be able to:

- Practice techniques of folding, cutting, tearing and pasting papers, cardboard to make objects and patterns.
- Design paper bags, envelopes, cards and face mask.
- Design models of sphere, cube, prism, cylinder and cone with clay or play dough.
- Design hammer, wheels, rollers and gears using clay or play dough.
- Operate mobile phones for use of calculator, alarm clock and calendar.
- Operate mobile phones for taking snap shots.
- Recognize the items of first aid box.
- Use digital and clinical thermometer externally to measure body temperature.
- Check blood pressure by digital blood pressure monitor.

## Resources

- Student's Book pages 110-116
- Workbook pages 54
- Fake thermometer and blood pressure apparatus
- First aid kit/doctor's play set

## Student's Book and lesson ideas<sup>1</sup>.

- Welcome the students into the class and ask them to sit at their tables.
- Ask the student what technology is and the technological devices they see in their daily lives.
- Evaluate how much time the students spend using mobiles, video games, or tv at home.
- Discuss on the pros and cons of using technology (e.g. too much can be bad for your eyesight etc.)

- Explain the difference between science and technology.

## 2.

- Welcome the students into the class and ask them to sit at their tables.
- Tell them to make an envelope and card for the person sitting next to them.
- Ask them if they know how to use a thermometer and blood pressure apparatus and role play using fake machines from a doctor's play set.
- Use the first aid kit in your class/school to show what things are in it and how some of them are used. A fake kit may also be used e.g., syringes and eye dropper etc., from a doctor's play set.

### Activities

- Arrange the students in groups or individually and read aloud the activities. Follow the instructions given in the Student's Book and Workbook.
- Help the students answer the questions from "In your notebook" and "Learning is fun" etc. Remind them that all the answers are in the Student's Book.

### Workbook steps

Help the students solve answers and activities in the Workbook. They may do these individually in class or as homework or they may work in groups of 2-3. After completing each task from the workbook, students may compare their answers and check their answers with each other.

### WORKBOOK ANSWERS

#### Fill in the blanks

1. 37°
2. 120 over 80 (120/80 mmHg)
3. Elastic/rubber

#### Crossword

Across

2. Mask
3. Temperature

Down

1. Paper

Name: \_\_\_\_\_

Date: \_\_\_\_\_

## Living Organisms

D	P	L	A	N	T	S	C	M	R	C	A
A	L	G	A	E	O	U	O	G	M	A	N
Y	Z	X	M	I	Z	H	M	O	Z	C	I
Y	D	I	V	E	R	S	I	T	Y	T	M
H	X	M	W	B	R	I	Z	A	K	U	A
Z	J	K	M	K	S	N	R	T	H	S	L
V	E	R	T	E	B	R	A	T	E	S	S
C	R	A	B	S	T	E	K	U	T	D	A

Find the following words in the puzzle. Words are hidden and .

ALGAE

CRABS

VERTEBRATES

ANIMALS

DIVERSITY

CACTUS

PLANTS



Name: \_\_\_\_\_

Date: \_\_\_\_\_

- 3) Vertebrates are \_\_\_\_\_ animals.
- 4) The most advanced group in the plant kingdom are known as \_\_\_\_\_
- 5) \_\_\_\_\_ and \_\_\_\_\_ are two types of non-flowering plants which do not produce seeds.
- 6) \_\_\_\_\_ involves just one plant, no reproductive cells and and no pollination.
- 7) Plants have two types of tubes: \_\_\_\_\_ and phloem.
- 8) \_\_\_\_\_ controls speech, thought, balance, movement, the senses, emotions, intelligence, dreams, and all other body functions.
- 9) Animals have \_\_\_\_\_ lungs.
- 10) The human body has more than \_\_\_\_\_ muscles.

Exercise 3: Label the diagram by picking up words from the word box:

Oxygen      sunlight      water      carbon dioxide      glucose

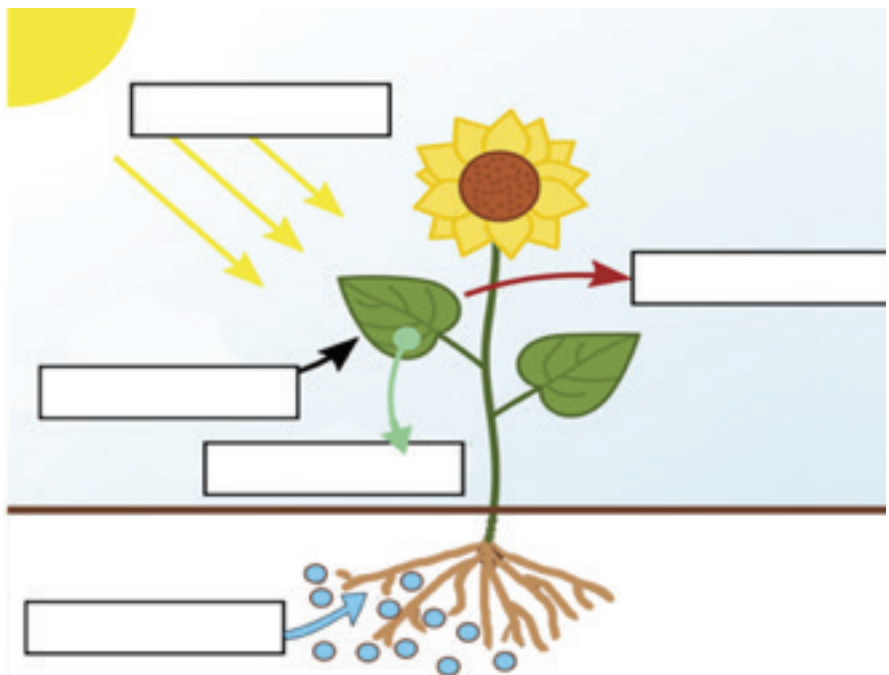



Name: \_\_\_\_\_

Date: \_\_\_\_\_

## Exercise 1: Fill in the blanks:

- \_\_\_\_\_ are all the humans, animals, plants and fungi in the ecosystem.
- \_\_\_\_\_ means differences. The more differences in an ecosystem, the more types of animals and plants it can have living within it.
- Grasslands are defined as areas where \_\_\_\_\_ predominate over large bushes or trees.
- South Pole is also called \_\_\_\_\_
- Half of the animals and plants live in \_\_\_\_\_.
- All the living things need three things for survival; oxygen, water, and \_\_\_\_\_
- A \_\_\_\_\_ shows us how energy is transferred through food.

## Exercise 2: Food Chain

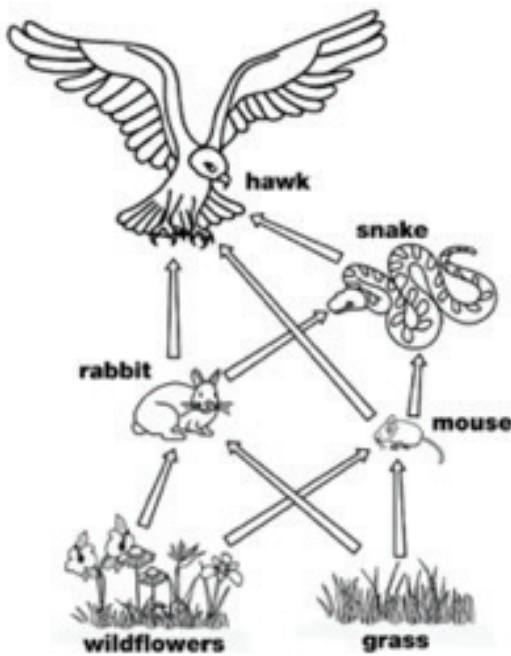

Name: \_\_\_\_\_

Date: \_\_\_\_\_

Use the food web in the picture above to answer the questions.

1. Name the living things in the food web that are producers.

---

2. Name the living things in the food web that are consumers.

---

3. Which living things does the snake eat?

---

4. Which living things does the hawk eat?

---

5. What is eaten by the rabbit?

---

Name: \_\_\_\_\_

Date: \_\_\_\_\_

Exercise 1: Read the following statements and Circle T if it is true or F if it is False.

1. Rainforests are divided into five zones.      T      F
2. There are two types of rainforests: tropical rainforest and temperate rainforest. T      F
3. Sahara Desert is the smallest desert in the world.      T      F
4. Cities are man-made ecosystems.      T      F
5. The more differences in an ecosystem, the more types of animals and plants it can have living within it.      T      F

Exercise 2: Write down two biotic factors and abiotic factors from the following picture.

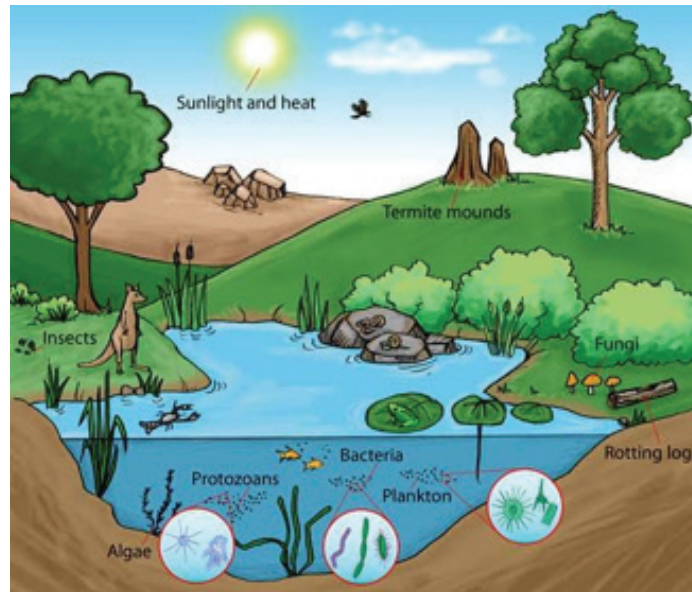

BIOTIC FACTORS	ABIOTIC FACTORS

Name: \_\_\_\_\_

Date: \_\_\_\_\_

## Human Health

Z	L	S	L	H	O	I	L	S	V	H	C
I	N	F	L	U	E	N	Z	A	F	P	K
F	A	T	P	O	L	I	O	K	H	O	E
B	C	H	I	C	K	E	N	P	O	X	Z
U	V	X	Q	N	T	A	W	S	C	F	L
P	R	O	T	E	I	N	Z	X	U	V	T
C	O	R	O	N	A	V	I	R	U	S	M
H	E	P	A	T	I	T	I	S	Z	P	M

Find the following words in the puzzle. Words are hidden  and .

CHICKENPOX

HEPATITIS

POLIO

CORONAVIRUS

INFLUENZA

PROTEIN

FAT

OILS

Name: \_\_\_\_\_

Date: \_\_\_\_\_

Exercise 1: Name two food examples for the following nutrients.

Minerals		
Fats		
Proteins		
Carbohydrates		

Exercise 2: Circle the odd one out. State the reason for circling the answer.

1. Stay at home, Wear Mask, Hug people, Wash your hands. \_\_\_\_\_
2. Coughing, Sneezing, Boiling, Runny nose. \_\_\_\_\_
3. Sweets, vegetables, cereals, meats, dairy \_\_\_\_\_

Exercise 3: What vitamins are present in the following food?

Fish	
Strawberries	
Milk	
Lemon	
Poultry	
Carrots	

Name: \_\_\_\_\_

Date: \_\_\_\_\_

Exercise 1: Complete the crossword puzzle below.

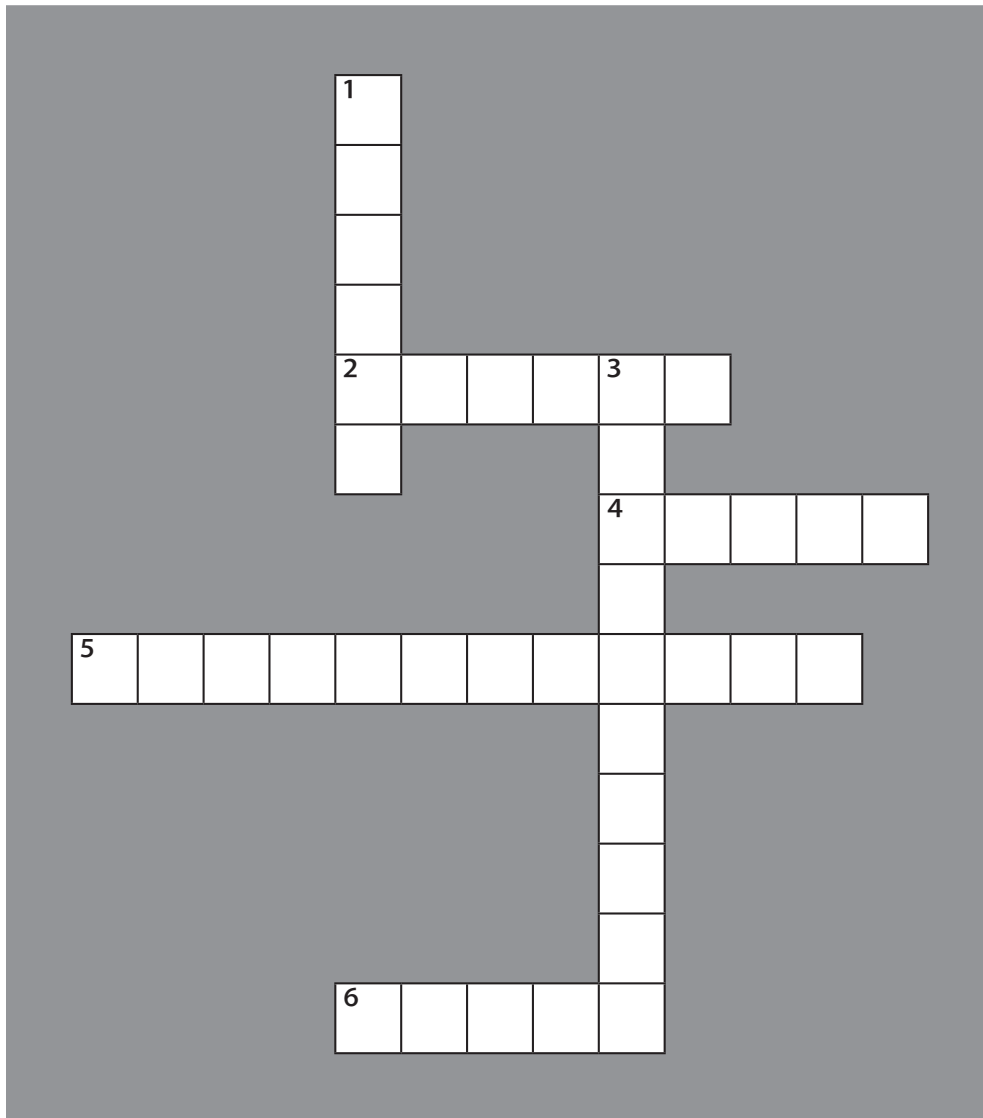

Across

- 2. it takes the shape of the container they are put into it.
- 4. The particles in it are pressed very tightly together
- 5. it refers to how easy it is to change
- 6. it doesn't have shape or volume

Down

- 1. These are minerals that are usually found in rocks under the ground
- 3. there are some materials that do not allow heat and electricity to pass-through them.

Name: \_\_\_\_\_

Date: \_\_\_\_\_

Exercise 1: Choose the correct answer:

1) Matter exists in three forms. 1) Solid 2) Liquid 3) \_\_\_\_\_

- a) Melting
- b) Gas
- c) Freezing
- d) All of these

2) \_\_\_\_\_ is the amount of matter an object has, and volume is that amount of space the matter takes up.

- a) Volume
- b) Mass
- c) Matter
- d) Box

3) There are some materials which allow the heat and electricity to pass through them easily. These materials are called \_\_\_\_\_

- a) Insulators
- b) Metals
- c) Conductors
- d) None of these

Exercise 2: Write two examples of the following.

Solid	Liquid	Gases

Name: \_\_\_\_\_

Date: \_\_\_\_\_

## Exercise 1: Fill in the blanks

1. \_\_\_\_\_ occur when sound waves are reflected or bounced off a surface.
2. The rainbow is where the sunlight looks white, but it is actually made up of \_\_\_\_\_ colours.
3. Sound waves travel \_\_\_\_\_ in cold water than in warm water.
4. Reverberation is when \_\_\_\_\_ continue to vibrate after the original source of the sound has stopped emitting sound.
5. Dolphins and bats use \_\_\_\_\_ to determine the location of objects using reflected sound

## Exercise 2: Choose the correct answer.

1. Iron changes electrical energy to
  - a) Heat energy
  - b) Sound Energy
2. A television changes electrical energy to
  - a) Sound Energy
  - b) Light Energy and Sound Energy
3. A speaker changes electrical energy to
  - a) Light energy
  - b) Sound Energy



Name: \_\_\_\_\_

Date: \_\_\_\_\_

Exercise 1: Write down the colours of the rainbow in order below.

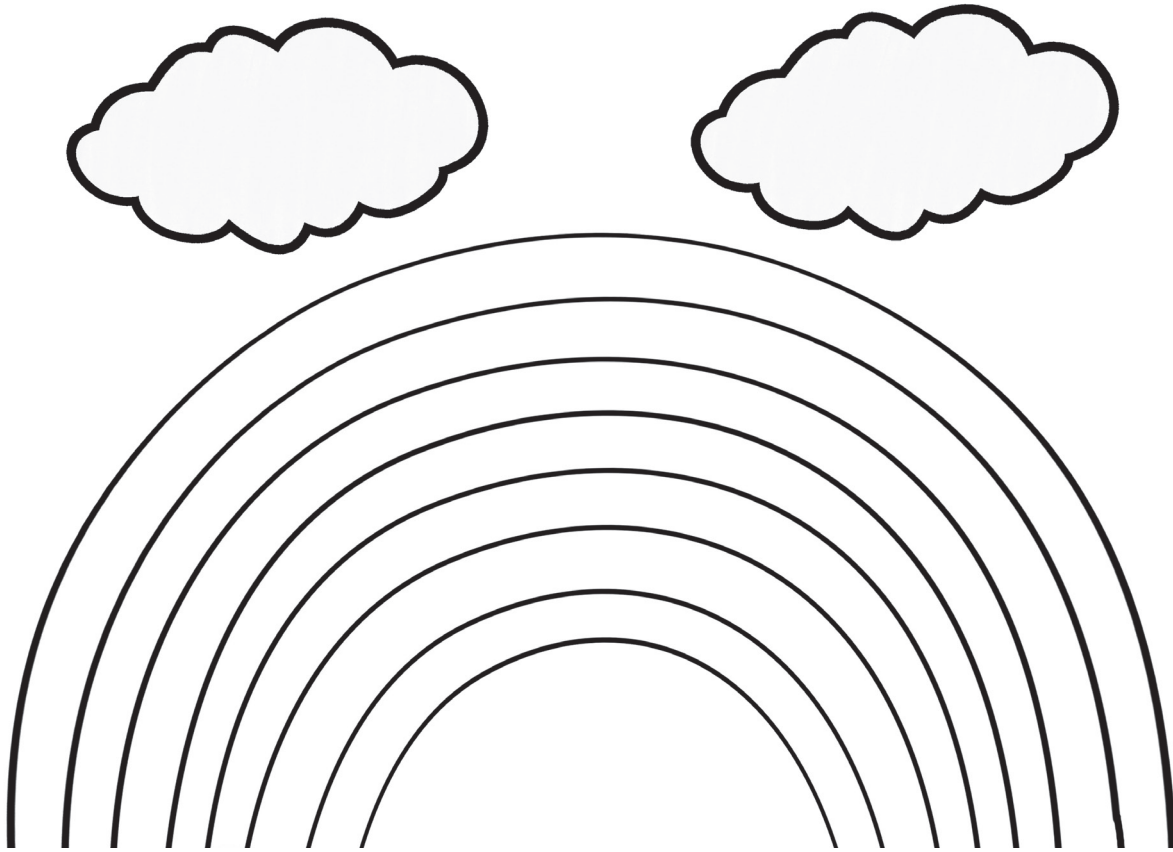

Exercise 2: Try converting using the below equation.

$$(^{\circ}\text{C} \times 9/5) + 32 = ^{\circ}\text{F}$$

1.  $24^{\circ}\text{C} \longrightarrow ^{\circ}\text{F}$

2.  $104^{\circ}\text{F} \longrightarrow ^{\circ}\text{C}$

3.  $35^{\circ}\text{C} \longrightarrow ^{\circ}\text{F}$

4.  $115^{\circ}\text{F} \longrightarrow ^{\circ}\text{C}$

5.  $20^{\circ}\text{C} \longrightarrow ^{\circ}\text{F}$

Name: \_\_\_\_\_

Date: \_\_\_\_\_

Exercise 1: Draw lines to match the pictures to the forces



Throw the ball •

- Object will move from one place to another



Use the brakes. •

- Start moving



Push the person on a swing •

- to slow down



Compress the dough •

- Falls down



Throw pencils •

- changes the form

Name: \_\_\_\_\_

Date: \_\_\_\_\_

crossword puzzle

# Force and Motion

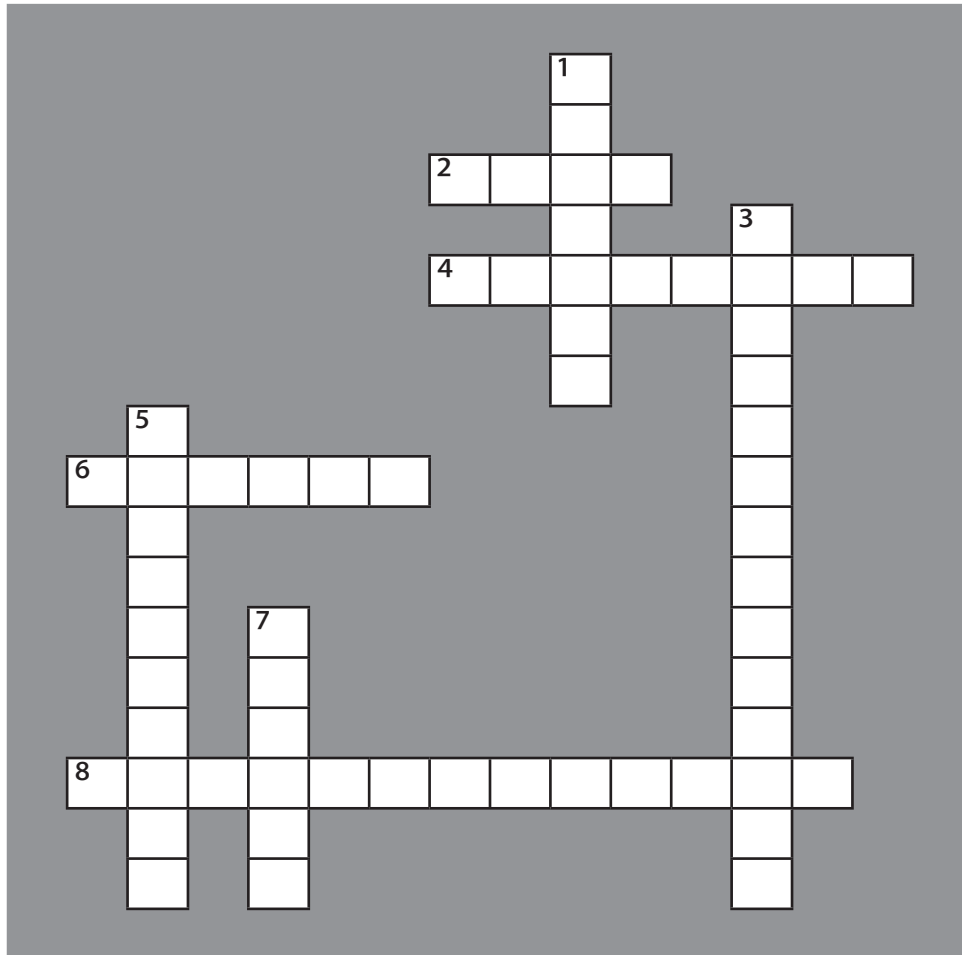

across:

- 2: It is wheels with teeth that helps increasing the speed of machine
- 4: It causes heat creating wear and tear in machines
- 6: It is two inclined planes joined together.
- 8: A ramp is a type of it

down:

- 1: The force that pulls the objects together.
- 3: These are tools which help us apply force and make our life easier
- 5: Liquids and gases are slow down by
- 7: It is a machine that has a wheel with a rope or chain wrapped around it

Name: \_\_\_\_\_

Date: \_\_\_\_\_

Exercise 1: Fill in the Blanks:

1. Water covers \_\_\_\_\_ the Earth's surface, with continents and islands making for the remaining 29%.
2. In \_\_\_\_\_, cold air cools the gas, and it changes into a liquid.
3. A \_\_\_\_\_ is defined as a slow-moving mass or river of ice, formed from snow on mountains or near the North Pole or South Pole.
4. Rain falls from the sky, but it begins as water on Earth. Water vapour rises into the air and later falls back as rain onto the Earth. This is called \_\_\_\_\_.
5. Trees are a \_\_\_\_\_ because forests are able to regrow.

Exercise 2: Complete the water cycle using the below words:

Collection	Condensation	Evaporation	Precipitation
------------	--------------	-------------	---------------

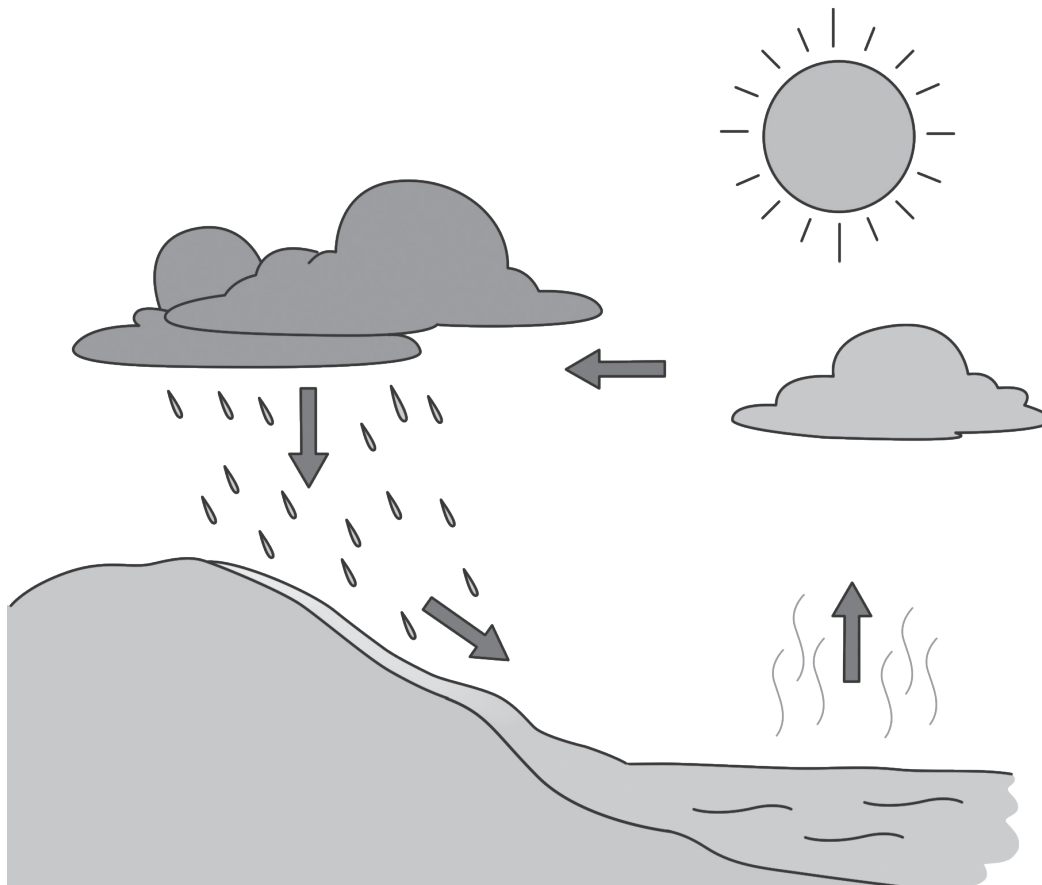

Name: \_\_\_\_\_

Date: \_\_\_\_\_

crossword puzzle  
EARTH AND ITS RESOURCES

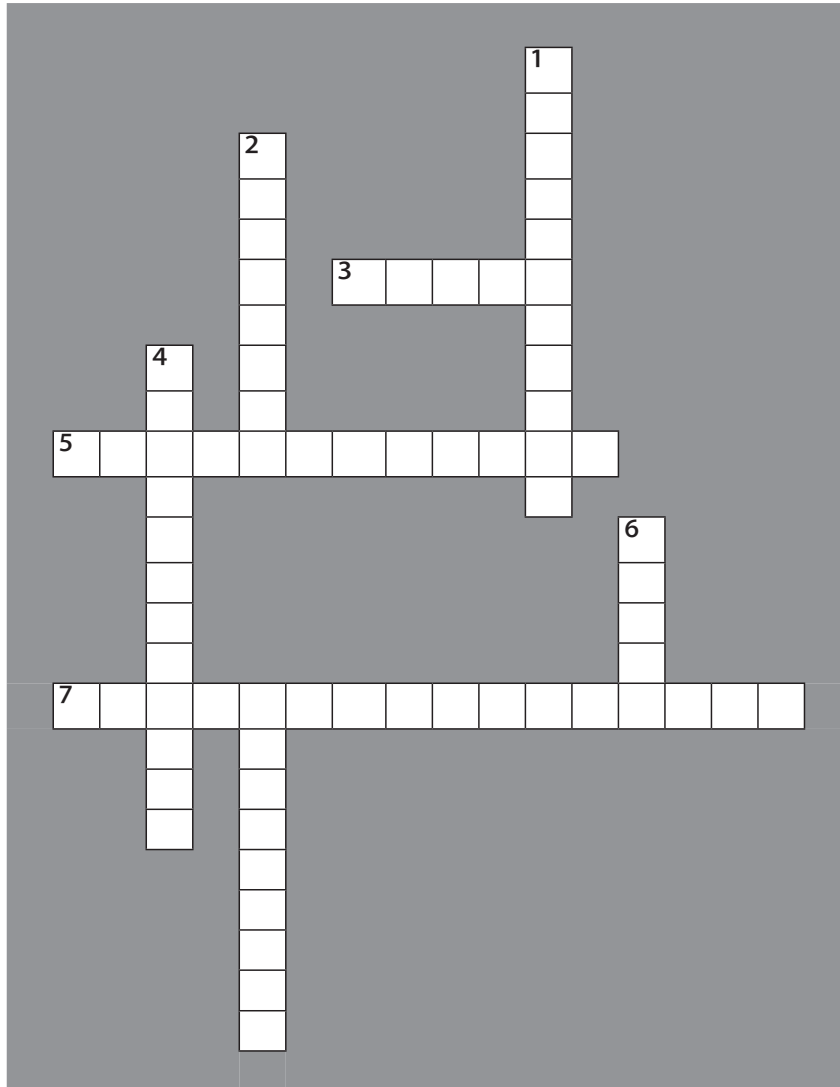

across:

- 3: A transparent, odorless, tasteless liquid.
- 5: The protection of plants and animals, natural areas, and interesting and important structures and buildings, especially from the damaging effects of human activity.
- 7: These are things that grow or are created naturally, without human help.

down:

- 1: when water is heated and is turned from a liquid into a gas.
- 2: They are resources that can only be used once.
- 4: Small drops of water that form on a cold surface.
- 6: It is the natural flow of water that continues in a long line across the land to the sea.

Name: \_\_\_\_\_

Date: \_\_\_\_\_

Exercise 1: Complete the Venn diagram with the below sentences.

short term	long term
temperature	precipitation
It is announced as	It is announced as
Forecasts	averages
changes slowly	changes fast
We can see it on a map	

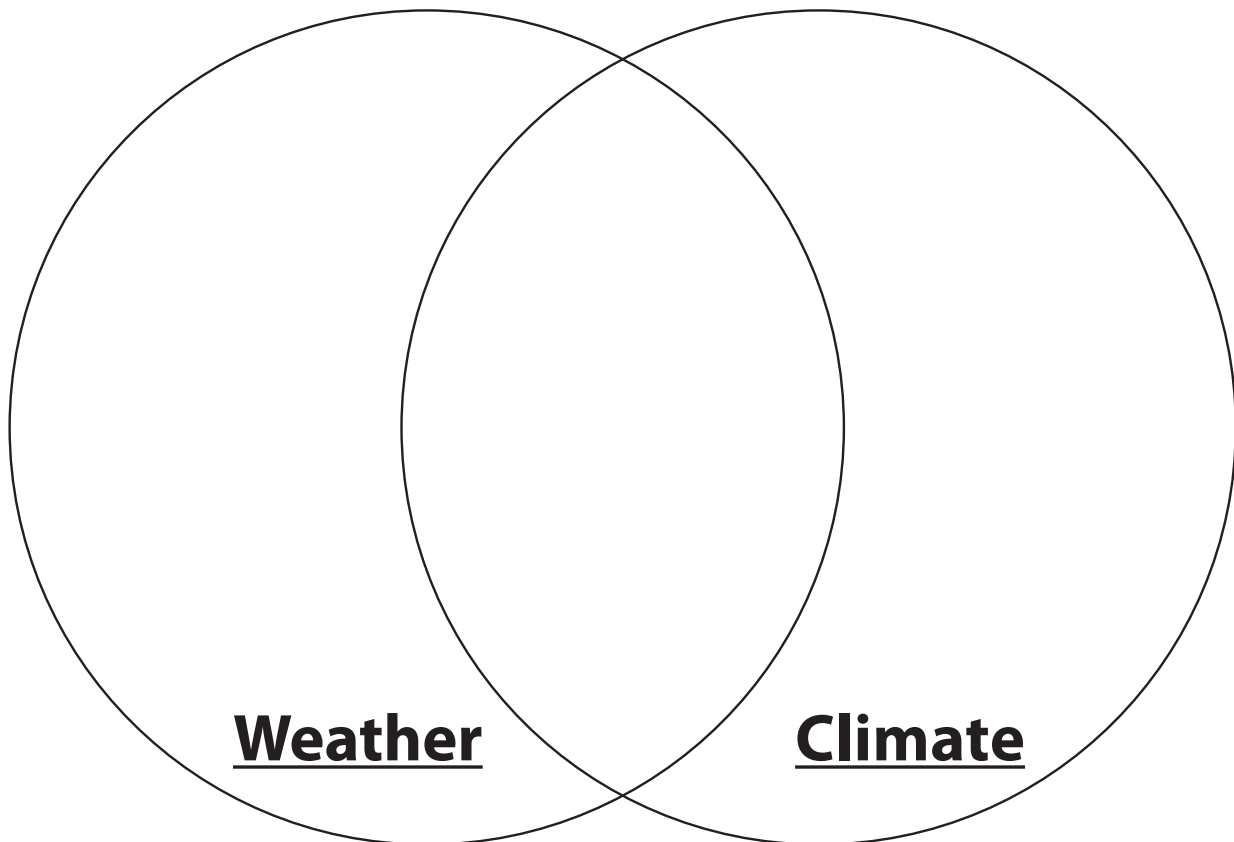

Name: \_\_\_\_\_

Date: \_\_\_\_\_

Exercise 1: Write one sentence for the weather below

Sunny	
Rainy	
Cloudy	
Stormy	
Snowy	

Exercise 2: Tick the correct answers

- 1) The climate of this zone is mild as the rays of the sun falling on it are slanted.
  - a) Polar zone
  - b) Tropic zone
  - c) Temperate zone
  
- 2) Which climate zone get the least precipitation?
  - a) Temperate Zone
  - b) Tropic Zone
  - c) Polar zone
  
- 3) The \_\_\_\_\_ zones are the coldest places on the Earth.
  - a) Polar
  - b) Tropic
  - c) Temperate

Name: \_\_\_\_\_

Date: \_\_\_\_\_

## Solar System

S	A	T	U	R	N	Q	I	G	F	Q	B
F	V	M	E	R	C	U	R	Y	B	W	V
W	F	U	R	A	N	U	S	E	D	M	E
N	W	Z	G	D	Z	P	V	A	E	A	N
M	C	L	Q	K	I	K	O	R	Y	R	U
X	J	U	P	I	T	E	R	T	B	S	S
D	I	A	Q	B	J	A	B	H	G	A	R
N	N	E	P	T	U	N	E	Z	S	I	B

Find the following words in the puzzle. Words are hidden  and .

EARTH

JUPITER

MARS

MERCURY

NEPTUNE

SATURN

URANUS

VENUS



Name: \_\_\_\_\_

Date: \_\_\_\_\_

Exercise 1: Explain the location of the sun, moon during a solar eclipse by making it.

Exercise 2: Answer the short questions

Q) Which moon phase is the brightest?

A)

Q) Which is the closest planet to the Sun?

A)

Q) Which planet is similar to Earth?

A)

Q) Which is the biggest planet in the solar system?

A)

SOLUTION

## Living Organisms

	P	L	A	N	T	S				C	A
A	L	G	A	E						A	N
										C	I
	D	I	V	E	R	S	I	T	Y	T	M
										U	A
										S	L
V	E	R	T	E	B	R	A	T	E	S	S
C	R	A	B	S							

**Exercise 1:**

Vertebrates	Invertebrates
Bear	Earth worm
Turtle	leech
eagle	snake
Spider	ant
tiger	

**Exercise 2:**

- 1) Coniferous trees
- 2) Invertebrates
- 3) warm-blooded
- 4) Angiosperms
- 5) Ferns, mosses
- 6) Asexual reproduction
- 7) xylem
- 8) Brain
- 9) two
- 10) 600

**Exercise 1:**

1. Biotic factors
2. Diversity
3. grasses
4. Antarctica.
5. rainforests.
6. energy.
7. food chain

**Exercise 2:**

1. Grass and Wildflowers
2. rabbit, mouse, snake, and hawk
3. Rabbit and mouse
4. rabbit, mouse, and snake
5. Grass and Wildflowers

**Exercise 1:**

1. False
2. True
3. False
4. True
5. False

**Exercise 2:**

BF: Sunlight, heat

AF: Frog, algae

## SOLUTION

## Human Health

					O	I	L	S			
I	N	F	L	U	E	N	Z	A			
F	A	T	P	O	L	I	O	K			
	C	H	I	C	K	E	N	P	O	X	
P	R	O	T	E	I	N					
C	O	R	O	N	A	V	I	R	U	S	
H	E	P	A	T	I	T	I	S			

**Exercise 1:**

- Milk (Calcium), Red Meat (Iron)
- Fish , doughnut
- Eggs, Almonds
- Carrots, Rice

**Exercise 2:**

1. Hug people
2. Boiling
3. Sweets

**Exercise 3:**

- Vitamin D
- Vitamin C
- Calcium
- Vitamin C
- Zinc
- Vitamin A

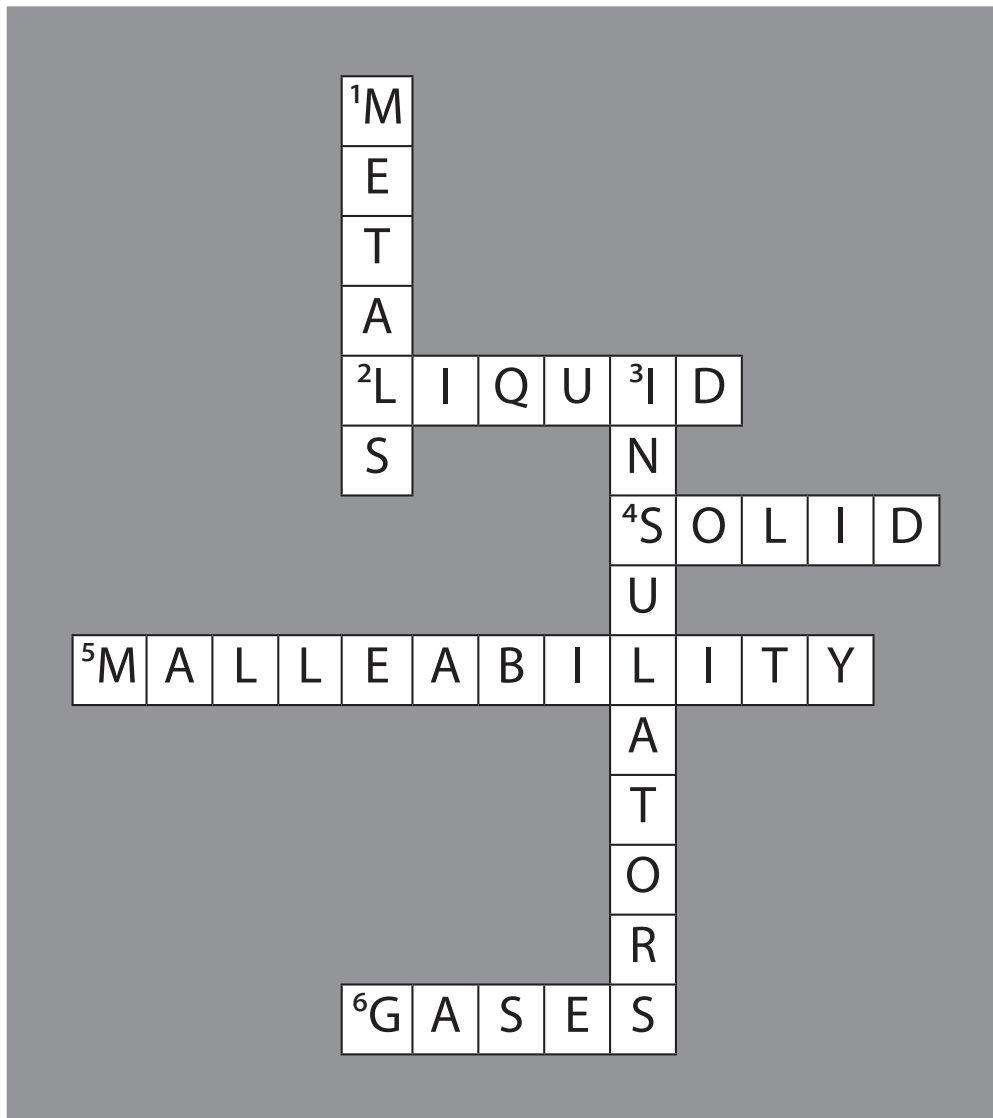

## Across

- It take the shape of the container they are put into it. (liquid)
- The particles in it are pressed very tightly together (solid)
- It refers to how easy it is to change (malleability)
- It doesn't have shape or volume (gases)

## Down

- It are minerals that are usually found in rocks under the ground
- there are some materials that do not allow heat and electricity to pass-through them.



**Exercise 1:**

1. B

2. B

3. C

**Exercise 2:**

Solid: Rock, Feather

Liquid: Water and Orange juice

Gases: Carbon dioxide gas, Hydrogen gas

**Exercise 1:**

1. Echoes
2. seven
3. more slowly
4. sound waves
5. echolocation

**Exercise 2:**

1. a
2. b
3. b

**Exercise 1:**

Violet

Indigo

Blue

Green

Yellow

Orange

Red

**Exercise 2:**

1. 75.2

2. 140

3. 95

4. 46.1

5. 68



Throw the ball

•

• Object will move from one place to another



Use the brakes.

•

• Start moving



Push the person on a swing

•

• to slow down



Compress the dough

•

• Falls down



Throw pencils

•

• changes the form

crossword puzzle

## Force and Motion

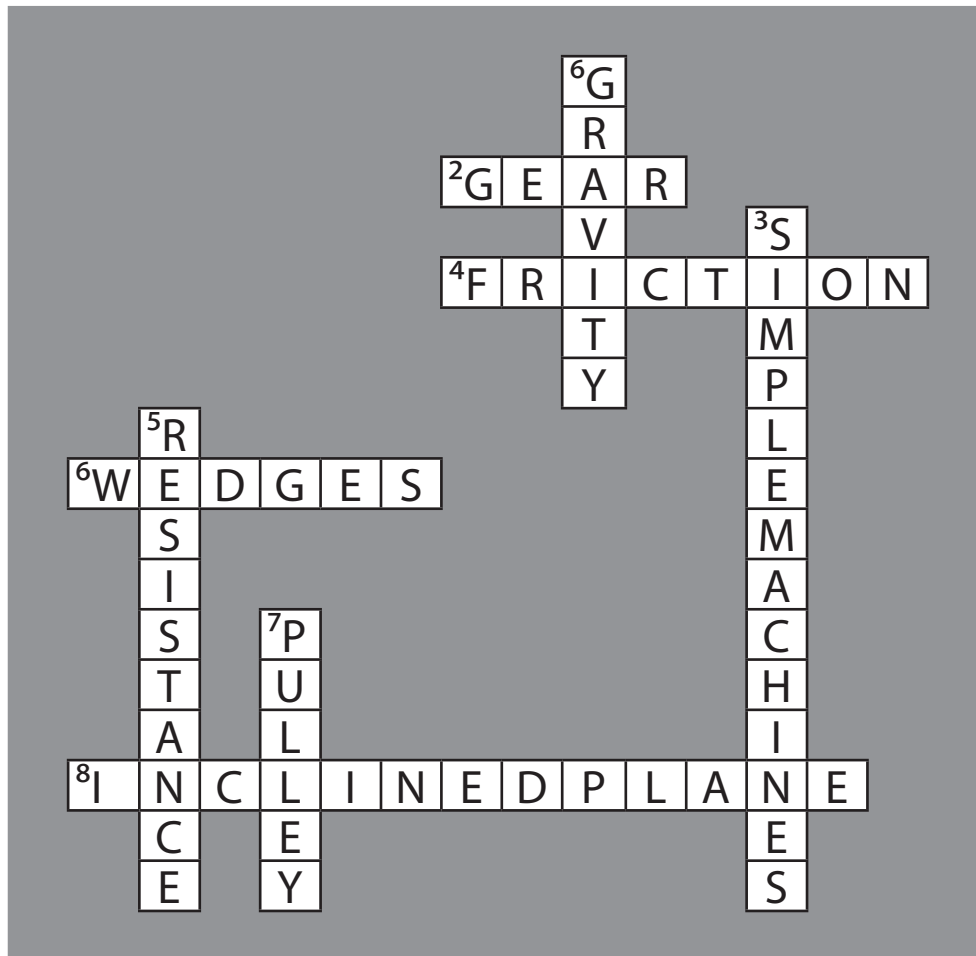

across:

- 2: It is wheels with teeth that helps increasing the speed of machine
- 4: It causes heat creating wear and tear in machines 6: It is two inclined planes joined together.
- 8: A ramp is a type of it

down:

- 1: The force that pulls to objects together.
- 3: These are tools which help us apply force and make our life easier
- 5: Liquids and gases are slow down by
- 7: It is a machine that has a wheel with a rope or chain wrapped around it

**Exercise 1:**

1. 71%
2. Condensation
3. glacier
4. Water Cycle.
5. renewable resource

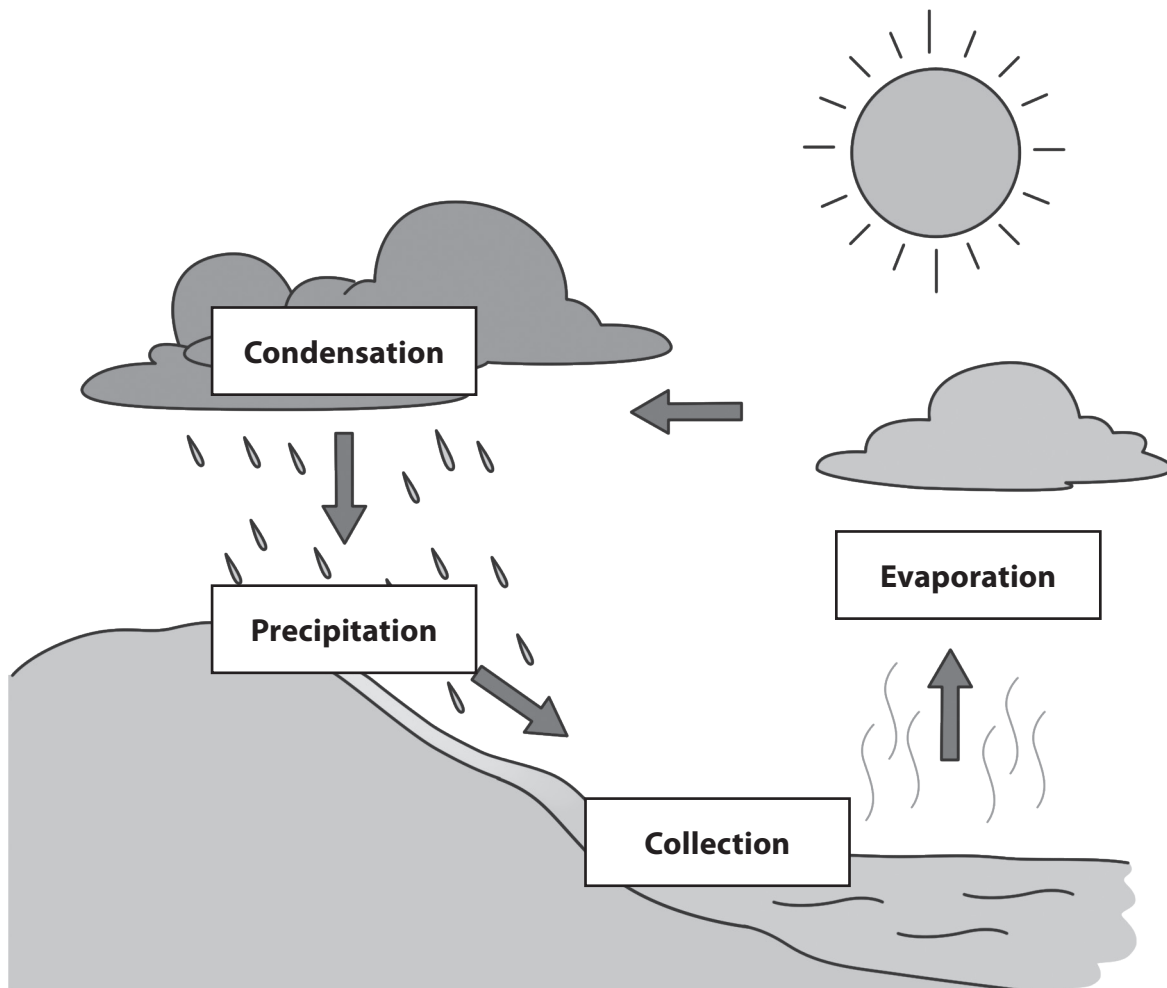
**Exercise 2:**

crossword puzzle

## EARTH AND ITS RESOURCES

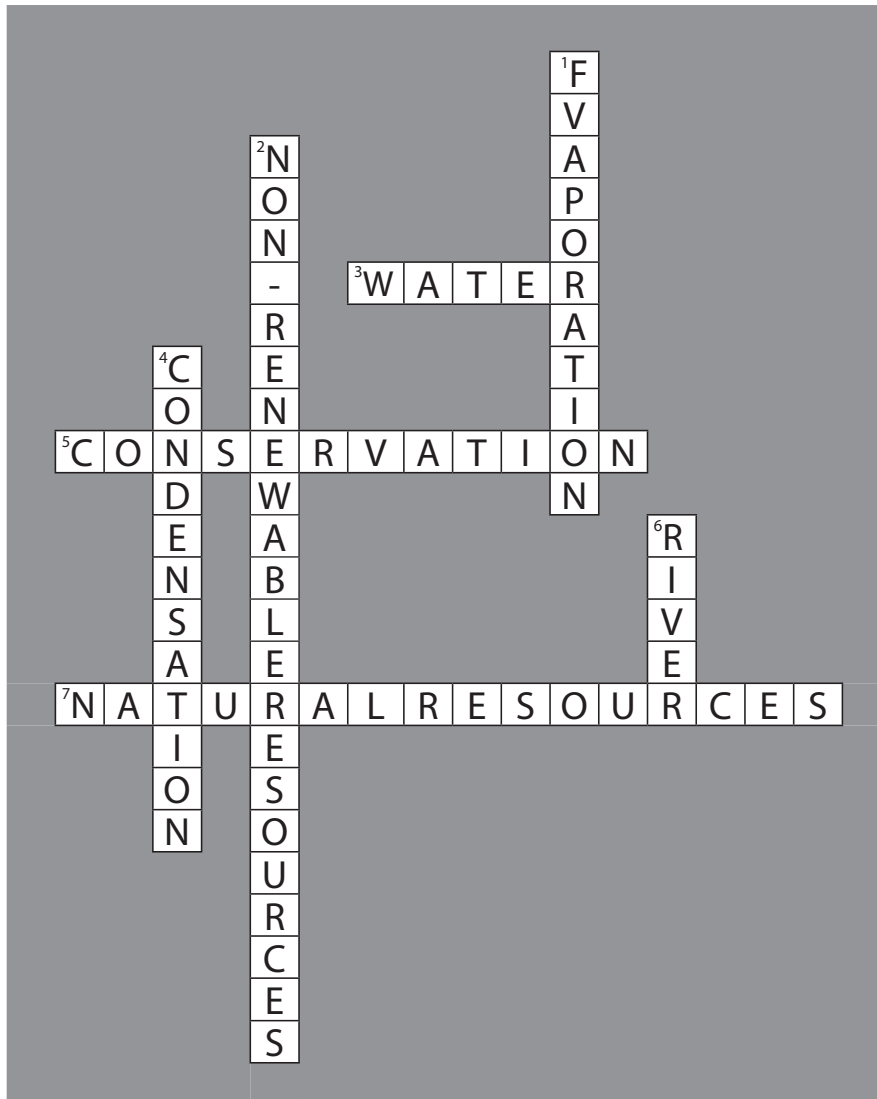

across:

- 3: A transparent, odorless, tasteless liquid.
- 5: The protection of plants and animals, natural areas, and interesting and important structures and buildings, especially from the damaging effects of human activity.
- 7: These are things that grow or are created naturally, without human help

down:

- 1: when water is heated and is turned from a liquid into a gas
- 2: They are resources that can only be used once. 4: Small drops of water that form on a cold surface.
- 6: It is the natural flow of water that continues in a long line across the land to the sea

short term	long term
temperature	precipitation
It is announced as	It is announced as
Forecasts	averages
changes slowly	changes fast
We can see it on a map	

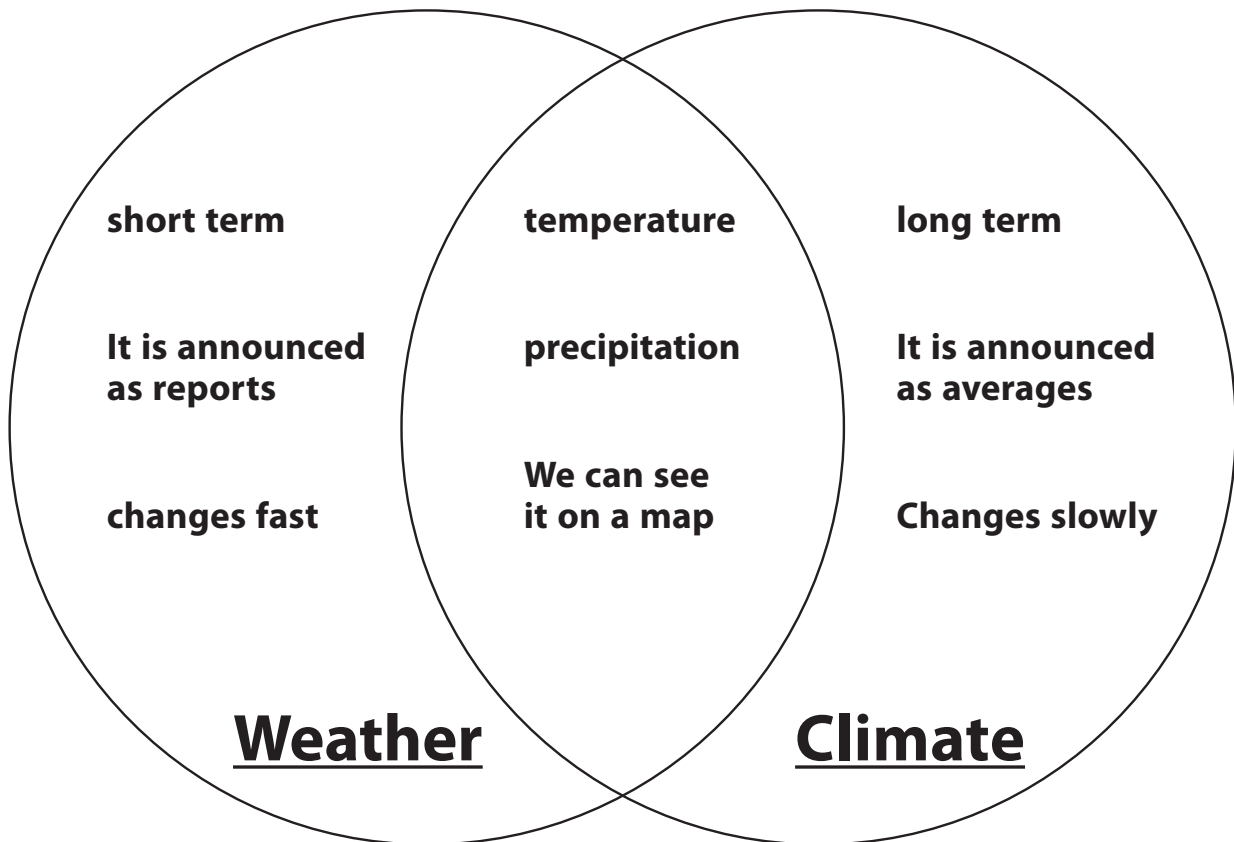



**Exercise 1 (examples):**

Sunny	In a sunny weather, I like to eat ice creams and cold drinks
Rainy	In the rainy season the roads become very wet
Cloudy	Today is cloudy and dirty.
Stormy	The weather was cold and stormy
Snowy	We walked across a snowy road.

**Exercise 2:**

- 1) c. Temperate zone
- 2) b. Tropic zone
- 3) a. Polar zone

SOLUTION

## Solar System

S	A	T	U	R	N						
		M	E	R	C	U	R	Y			V
		U	R	A	N	U	S	E		M	E
								A		A	N
								R		R	U
	J	U	P	I	T	E	R	T		S	S
								H			
	N	E	P	T	U	N	E				

**Exercise 1:**

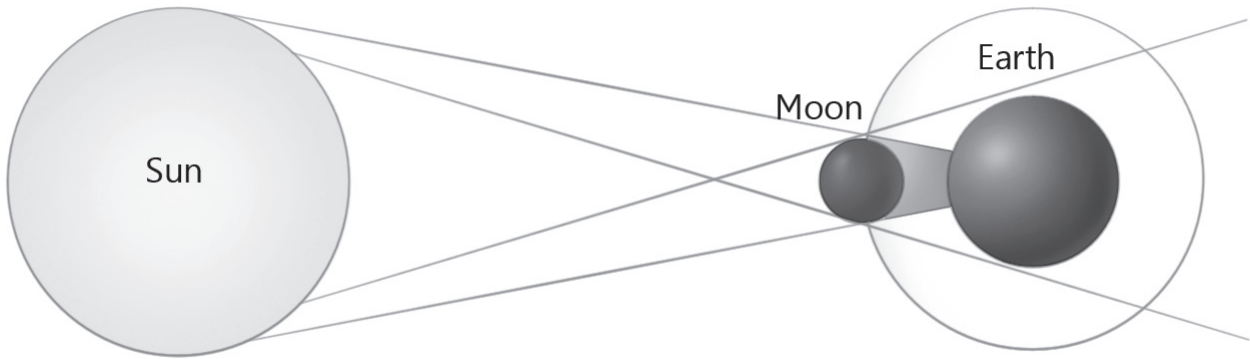

**Exercise 2:**

- 1) Full moon
- 2) Mercury
- 3) Mars
- 4) Jupiter